

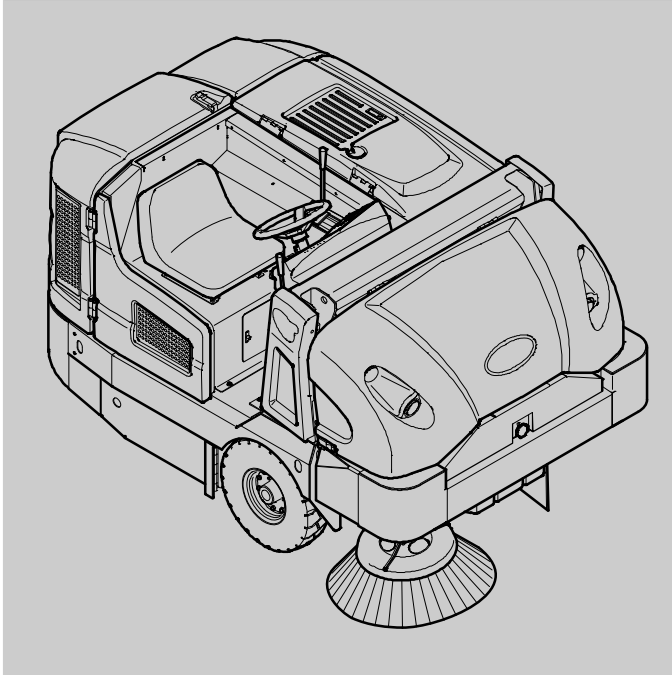

# S30

(Diesel)



Sweeper  
English **EN**  
Operator Manual



**SweepMax<sup>®</sup> Plus**  
**TennantTrue<sup>®</sup> Parts**  
**IRIS<sup>®</sup> a Tennant Technology**



For the latest Parts manuals and other language Operator manuals, visit:

[www.tennantco.com/manuals](http://www.tennantco.com/manuals)

**9004648**  
**Rev. 11 (1-2017)**



## INTRODUCTION

This manual is furnished with each new model. It provides necessary operation and maintenance instructions.



**Read this manual completely and understand the machine before operating or servicing it.**

This machine will provide excellent service. However, the best results will be obtained at minimum costs if:

- The machine is operated with reasonable care.
- The machine is maintained regularly - per the machine maintenance instructions provided.
- The machine is maintained with manufacturer supplied or equivalent parts.

PROTECT THE ENVIRONMENT	MACHINE DATA
	Please fill out at time of installation for future reference.
Please dispose of packaging materials, used components such as batteries and fluids in an environmentally safe way according to local waste disposal regulations.	
	Model No. – _____
Always remember to recycle.	Serial No. – _____
	Installation Date – _____

## INTENDED USE

The S30 is an industrial rider machine designed to sweep hard surfaces (concrete, asphalt, stone, synthetic, etc). Typical applications include industrial warehouses, manufacturing facilities, distribution facilities, stadiums, arenas, convention centers, parking facilities, transportation terminals, and construction sites. Do not use this machine on soil, grass, artificial turf, or carpeted surfaces. This machine can be used both indoors and outdoors, but ensure there is adequate ventilation if used indoors. Do not use this machine other than described in this Operator Manual.

### Tennant N.V.

Industrielaan 6 5405 AB  
P.O. Box 6 5400 AA Uden–The Netherlands  
europe@tennantco.com  
www.tennantco.com

Specifications and parts are subject to change without notice.

Original instructions, copyright © 2008, 2010, 2012, 2014 – 2017 TENNANT Company, Printed in The Netherlands. All rights reserved

**CONTENTS**

	Page		Page
Safety Precautions .....	3	Maintenance .....	32
Operation .....	7	Maintenance Chart .....	32
Machine Components .....	7	Lubrication .....	35
Controls And Instruments .....	8	Engine Oil .....	35
Touch Panel (S30 XP and X4) .....	8	Rear Wheel Support (S30 and S30 XP) .....	35
Symbol Definitions .....	9	Steering Cylinder Bearing (S30 and S30 XP) (S/N 000000 – 006766) .....	35
Operation Of Controls .....	10	Hopper Lift Arm Bearings .....	35
Directional Pedal .....	10	Steering Rod End (S30 X4) .....	36
Brake Pedal .....	10	Steering Spindles (S30 X4) .....	36
Parking Brake Pedal .....	10	Front Wheel Bearings .....	36
Steering Column Tilt Pedal .....	10	Hydraulics .....	37
Fuel Gauge .....	11	Hydraulic Fluid .....	38
Hour Meter .....	12	Hydraulic Hoses .....	38
Supervisor Control Buttons (S30 XP and X4) .....	12	Engine .....	39
Engine Speed Controls .....	12	Cooling System .....	39
Vacuum Fan Controls (S30) .....	13	Air Filter Indicator .....	40
Vacuum Fan Controls (S30 XP and X4) .....	13	Air Filter .....	40
Contrast Control Button (S30 XP and X4) .....	13	Fuel Filter .....	41
Filter Shaker Control (S30) .....	14	Fuel Lines .....	41
Filter Shaker Control (S30 XP and X4) .....	14	Priming The Fuel System .....	42
Operating / Hazard Light Switch .....	14	Engine Belt .....	42
Side Brush Light Switch (Option) .....	14	Battery .....	42
Hopper Access Door .....	15	Fuses And Relays .....	43
Operator Seat .....	16	Relay Panel Fuses And Relays .....	43
Deluxe Suspension Seat .....	16	Engine Harness Relays .....	44
Seat Belts .....	16	Cab Fuses (Cab Option) .....	44
Brush Information .....	17	Removing And Inspecting The Dust Filter (SN 000000 – 006500) .....	45
How The Machine Works .....	17	Removing And Inspecting The Dust Filter (SN 006501 – ) .....	46
Pre-Operation Checklist .....	18	Cleaning The Dust Filter .....	47
Starting The Machine .....	19	Cleaning The Cyclone Assembly (SN 006501 – ) .....	47
Turning Off The Machine .....	19	Main Brush .....	48
While Operating The Machine .....	20	Replacing Or Rotating The Main Brush .....	48
Sweeping (S30) .....	21	Checking The Main Brush Pattern .....	50
Sweeping (S30 XP and X4) .....	22	Adjusting The Main Brush Taper .....	50
Emptying The Hopper .....	23	Adjusting The Main Brush Width .....	51
Engaging The Hopper Support Bar .....	24	Side Brush .....	51
Disengaging The Hopper Support Bar .....	24	Replacing The Side Brush .....	51
Display Module Fault Indicators (S30) .....	25	Adjusting The Side Brush Pattern .....	52
Fault Indicator(s) (S30 XP and X4) .....	26	Rotating And Replacing The Side Brush Guard .....	52
Dash Fault Indicators .....	27	Skirts And Flaps .....	53
Options .....	28	Hopper Skirts .....	53
Wand (Option) .....	28	Brush Door Skirts .....	53
Heater / Air Conditioner Controls (Option) .....	29	Rear Skirts .....	53
Windshield Wiper Switch (Option) .....	29	Recirculation Flap .....	53
Cab Light Switch (Option) .....	29		
Tower Bumpers (Option) .....	30		
Machine Troubleshooting .....	31		

# CONTENTS

---

	Page
Seals .....	54
Brush Door Seals .....	54
Hopper Seals .....	54
Hopper Inspection Door Seals .....	54
Filter Chamber Inlet Seal .....	54
Cyclonic Pre-Filter Seals .....	55
Dust Return Seals	
(SN 000000 – 006500) .....	55
Dust Filter Seals	
(SN 000000 – 006500) .....	55
Vacuum Wand Door Seals (Option) ...	55
Cyclonic Dust Tray Seals	
(SN 006501 –       ) .....	56
Cyclone Perma-Filter	
(SN 006501 –       ) .....	56
Cyclone Cover Seals	
(SN 006501 –       ) .....	56
Cyclone Cover Access Port Seal	
(SN 006501 –       ) .....	56
Hopper Dust Filter Cover Seal	
(SN 006501 –       ) .....	56
Brakes And Tires .....	57
Brakes .....	57
Tires .....	57
Rear Wheel .....	57
Propelling Motor .....	57
Pushing, Towing, And Transporting	
The Machine .....	58
Pushing Or Towing The Machine .....	58
Transporting The Machine .....	58
Machine Jacking .....	60
Storage Information .....	60
Specifications .....	61
General Machine Dimensions/Capacities .	61
General Machine Performance .....	61
Hydraulic System .....	62
Steering .....	62
Power Type .....	62
Tires .....	62
Machine Dimensions .....	63

**IMPORTANT SAFETY INSTRUCTIONS – SAVE THESE INSTRUCTIONS**

The following precautions are used throughout this manual as indicated in their description:

 **WARNING:** To warn of hazards or unsafe practices that could result in severe personal injury or death.

 **CAUTION:** To warn of unsafe practices that could result in minor or moderate personal injury.

**FOR SAFETY:** To identify actions that must be followed for safe operation of equipment.

The following information signals potentially dangerous conditions to the operator. Know when these conditions can exist. Locate all safety devices on the machine. Report machine damage or faulty operation immediately.

 **WARNING:** Moving belt and fan. Keep away.

 **WARNING:** Machine emits toxic gases. Serious injury or death can result. Provide adequate ventilation.

 **WARNING:** Raised hopper may fall. Engage hopper support bar.

 **WARNING:** Lift arm pinch point. Stay clear of hopper lift arms.

 **WARNING:** Burn hazard. Hot surface. Do NOT touch.

 **WARNING:** Accident may occur. Do not operate vacuum or blower wand while driving.

This machine may be equipped with technology that automatically communicates over the cellular network. If this machine will be operated where cell phone use is restricted because of concerns related to equipment interference, please contact a Tennant representative for information on how to disable the cellular communication functionality.

**FOR SAFETY:**

1. **Do not operate machine:**
  - Unless trained and authorized.
  - Unless operator manual is read and understood.
  - Under the influence of alcohol or drugs.
  - While using a cell phone or other types of electronic devices.
  - Unless mentally and physically capable of following machine instructions.
  - If it is not in proper operating condition.
  - Without filters in place.
  - In areas where flammable vapors/liquids or combustible dusts are present.
  - In areas that are too dark to safely see the controls or operate the machine unless operating / headlights are turned on.
  - In areas with possible falling objects unless equipped with overhead guard.
2. **Before starting machine:**
  - Check machine for fluid leaks
  - Keep sparks and open flame away from refueling area.
  - Make sure all safety devices are in place and operate properly.
  - Check brakes and steering for proper operation.
  - Adjust seat and fasten seat belt (if equipped).
3. **When starting machine:**
  - Keep foot on brake and directional pedal in neutral.

## SAFETY PRECAUTIONS

### 4. When using machine:

- Use only as described in this manual.
- Do not pick up burning or smoking debris, such as cigarettes, matches or hot ashes
- Use brakes to stop machine.
- Go slow on inclines and slippery surfaces.
- Do not sweep on ramp inclines that exceed 14% grade or transport (GVWR) on ramp inclines that exceed 17% grade.
- Reduce speed when turning.
- Keep all parts of body inside operator station while machine is moving.
- Always be aware of surroundings while operating machine.
- Use care when reversing machine.
- Move machine with care when hopper is raised.
- Do not raise hopper when machine is on an incline.
- Make sure adequate clearance is available before raising hopper.
- Keep children and unauthorized persons away from machine.
- Do not carry passengers on machine.
- Always follow safety and traffic rules.
- Report machine damage or faulty operation immediately.

### 5. Before leaving or servicing machine:

- Do not park near combustible materials, dusts, gases, or liquids.
- Stop on level surface.
- Set parking brake.
- Turn off machine and remove key.

### 6. When servicing machine:

- All work must be done with sufficient lighting and visibility.
- Keep work area well ventilated.
- Avoid moving parts. Do not wear loose clothing, jewelry and secure long hair.
- Block machine tires before jacking machine up.
- Jack machine up at designated locations only. Support machine with jack stands.
- Use hoist or jack that will support the weight of the machine.
- Do not push or tow the machine without an operator in the seat.
- Do not power spray or hose off machine near electrical components.
- Disconnect battery connections before working on machine.

- Avoid contact with battery acid.
- Avoid contact with hot engine coolant.
- Do not remove cap from radiator when engine is hot.
- Allow engine to cool.
- Keep flames and sparks away from fuel system service area. Keep area well ventilated.
- Use cardboard to locate leaking hydraulic fluid under pressure.
- All repairs must be performed by a trained service mechanic.
- Do not modify the machine from its original design.
- Use Tennant supplied or approved replacement parts.
- Wear personal protective equipment as needed and where recommended in this manual.



For Safety: wear hearing protection.



For Safety: wear protective gloves.



For Safety: wear eye protection.



For Safety: wear protective dust mask.

### 7. When loading/unloading machine onto/off truck or trailer:

- Empty debris hopper before loading machine.
- Turn off machine and remove key.
- Use ramp, truck or trailer that will support the weight of the machine and operator.
- Do not load/unload on ramp inclines that exceed 25% grade.
- Use winch. Do not drive the machine onto/off the truck or trailer unless the load height is 380 mm (15 in) or less from the ground.
- Set parking brake after machine is loaded.
- Block machine tires.
- Tie machine down to truck or trailer.

# SAFETY PRECAUTIONS

The safety labels appear on the machine in the locations indicated. Replace damaged labels.

**WARNING LABEL – Machine emits toxic gases. Serious injury can result. Provide adequate ventilation.**

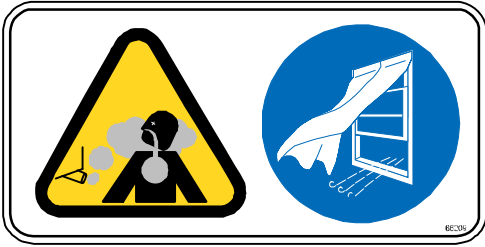

Located on the side of the operator compartment.

**WARNING LABEL – Moving belt and fan. Keep away.**



Located on engine belt guard.

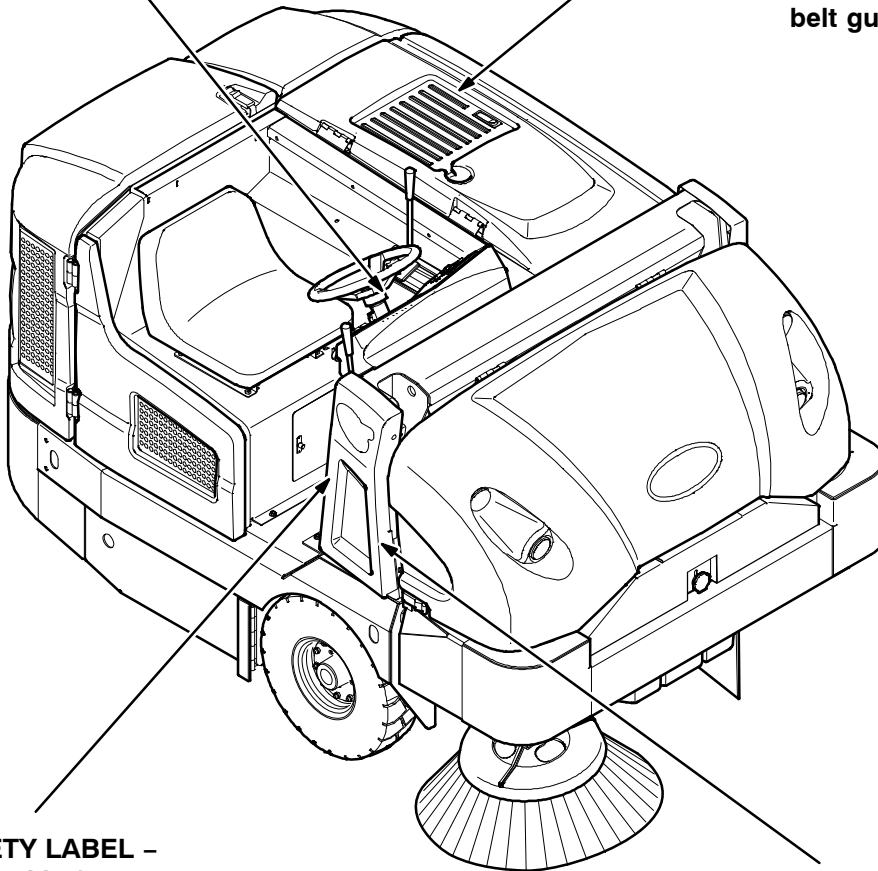

**FOR SAFETY LABEL – Read manual before operating machine.**



Located on the side of the operator compartment.

**WARNING LABEL – Lift arm pinch point. Stay clear of hopper lift arms.**



Located on both hopper lift arms.

354590

# SAFETY PRECAUTIONS

**WARNING LABEL – Burn hazard. Do NOT touch.**



Located on the exhaust shield.

**WARNING LABEL – Raised hopper may fall. Engage hopper support bar.**

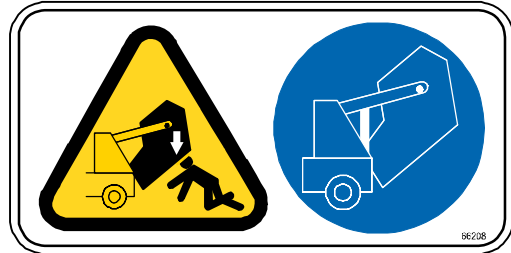

Located on the hopper support bar.

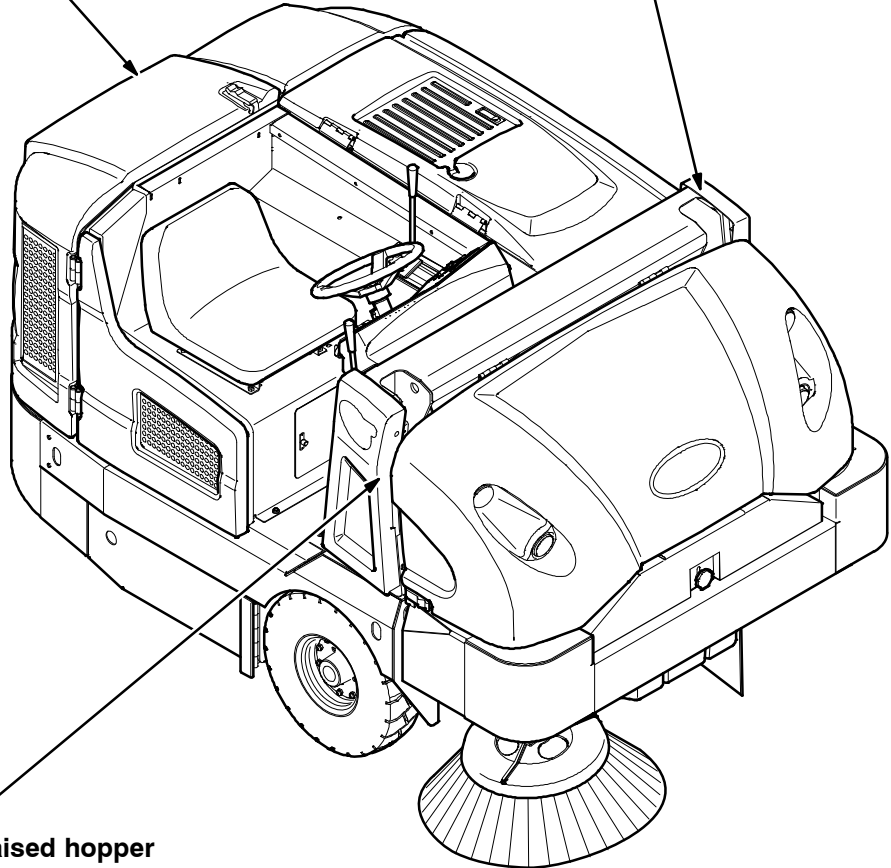

**WARNING LABEL – Raised hopper may fall. Engage hopper support bar.**

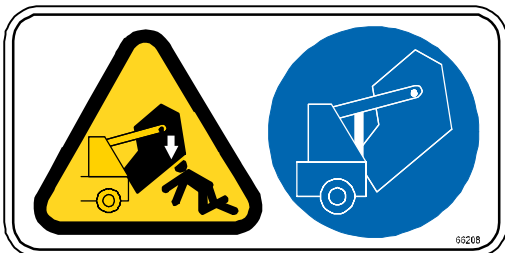

Located on the hopper lift arm.

**WARNING LABEL – Accident may occur. Do not operate vacuum or blower wand while driving.**

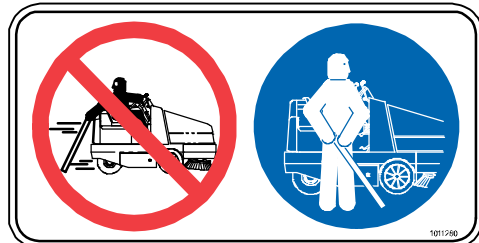

Located on the optional vacuum or blower wand door.

354590



## OPERATION

## MACHINE COMPONENTS



- |                           |                        |
|---------------------------|------------------------|
| 1. Instrument panel       | 8. Fuel tank           |
| 2. Front shroud           | 9. Operator seat       |
| 3. Hopper access door     | 10. Rear engine shroud |
| 4. Hopper                 | 11. Taillights         |
| 5. Side brush             | 12. Side shroud        |
| 6. Headlights             | 13. Hopper support bar |
| 7. Main brush access door | 14. Top cover          |

## CONTROLS AND INSTRUMENTS

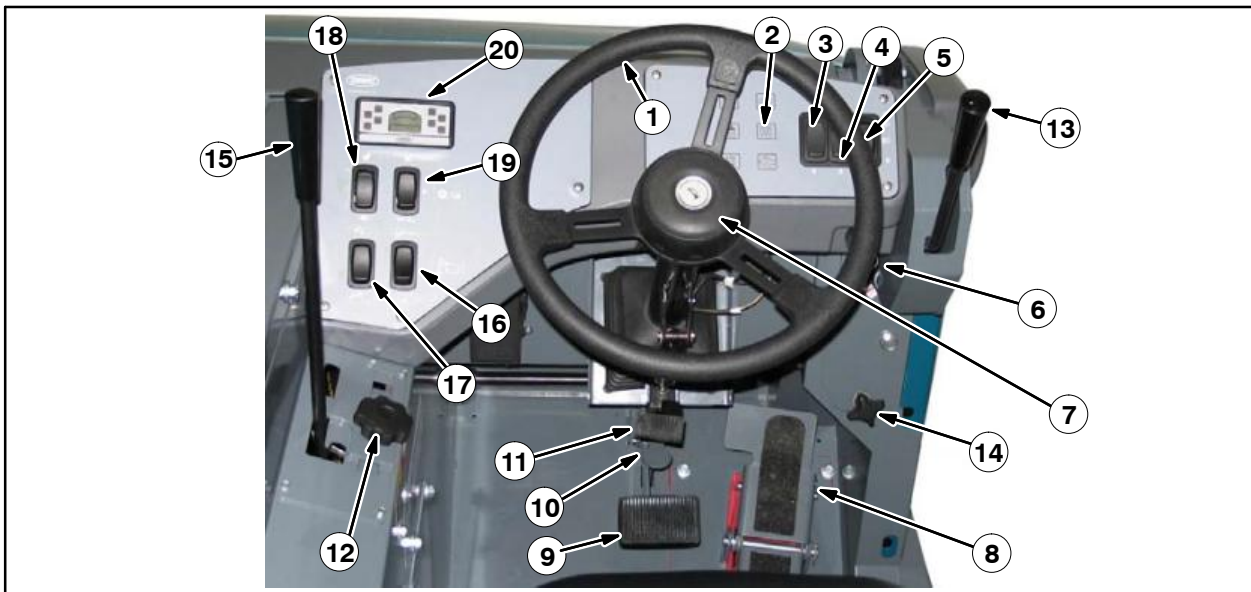

(All models)

- |  |   |
|--|---|
| <ol style="list-style-type: none"> <li>1. Steering wheel</li> <li>2. Dash Fault Indicator lights</li> <li>3. Wand switch (option)</li> <li>4. Side brush light switch (option)</li> <li>5. Operating / hazard light switch</li> <li>6. Ignition switch</li> <li>7. Horn button</li> <li>8. Directional pedal</li> <li>9. Brake pedal</li> <li>10. Parking brake pedal</li> </ol> | <ol style="list-style-type: none"> <li>11. Steering column tilt pedal</li> <li>12. Main brush adjustment knob (S30 only)</li> <li>13. Side brush lever</li> <li>14. Side brush adjustment knob</li> <li>15. Main brush lever</li> <li>16. Hopper door switch</li> <li>17. Hopper raise / lower switch</li> <li>18. Engine speed switch</li> <li>19. Vacuum fan / filter shaker switch</li> <li>20. Indicator panel</li> </ol> |
|--|---|



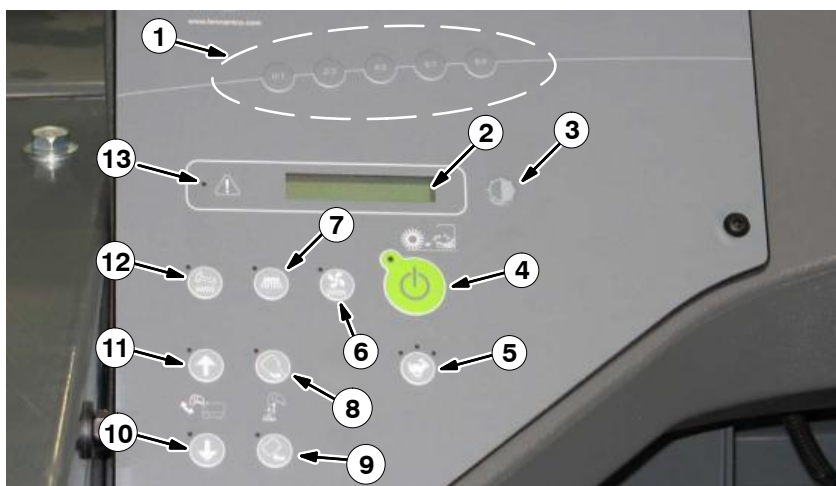

























## TOUCH PANEL (S30 XP and X4)



- |  |  |
|--|--|
| <ol style="list-style-type: none"> <li>1. Supervisor control buttons</li> <li>2. Hour meter / fuel indicator / fault code indicator</li> <li>3. Contrast control button</li> <li>4. 1-STEP sweep button</li> <li>5. Engine speed button</li> <li>6. Vacuum fan button</li> </ol> | <ol style="list-style-type: none"> <li>7. Side brush button</li> <li>8. Hopper door open button</li> <li>9. Hopper door close button</li> <li>10. Hopper lower button</li> <li>11. Hopper raise button</li> <li>12. Filter shaker button</li> <li>13. Fault indicator light</li> </ol> |
|--|--|

**SYMBOL DEFINITIONS**

These symbols are used on the machine to identify controls, displays, and features. See also *Display Module Fault Indicators (S30)* and *Dash Fault Indicators*.

	Sweep (S30)		Jack point
	Vacuum fan (S30)		Fault indicator (S30 XP and X4)
	Filter Shaker (S30)		Contrast Control (S30 XP and X4)
	Engine Idle Speed (S30)		1-STEP Sweep (S30 XP and X4)
	Engine High speed (S30)		Engine speed (S30 XP and X4)
	Empty Hopper (S30)		Vacuum fan (S30 XP and X4)
	Hopper Door Automatic (S30)		Side brush (S30 XP and X4)
	Hopper Door Manual Open (S30)		Filter shaker (S30 XP and X4)
	Hopper Lower (S30)		Hopper Up / Down (S30 XP and X4)
	Hopper Raise (S30)		Hopper raise (S30 XP and X4)
	Wand		Hopper lower (S30 XP and X4)
	Operating lights		Open/Close Hopper Door (S30 XP, X4)
	Hazard light		Hopper door open (S30 XP and X4)
	Horn		Hopper door close (S30 XP and X4)
	Diesel fuel only		

# OPERATION

## OPERATION OF CONTROLS

### DIRECTIONAL PEDAL

Press the top of the *Directional pedal* to move forward and the bottom of the pedal to move backward. The pedal returns to the neutral position when it is released.

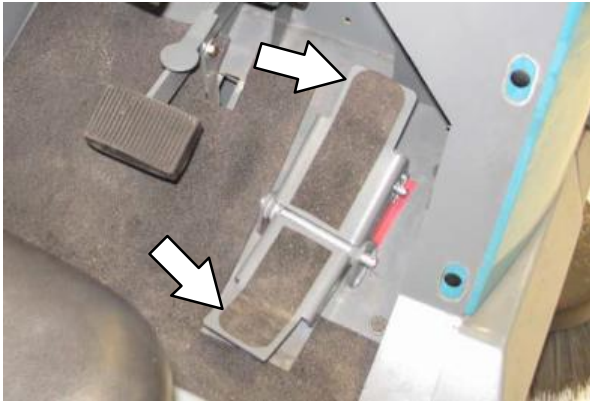

### BRAKE PEDAL

Press the *Brake pedal* to stop the machine.

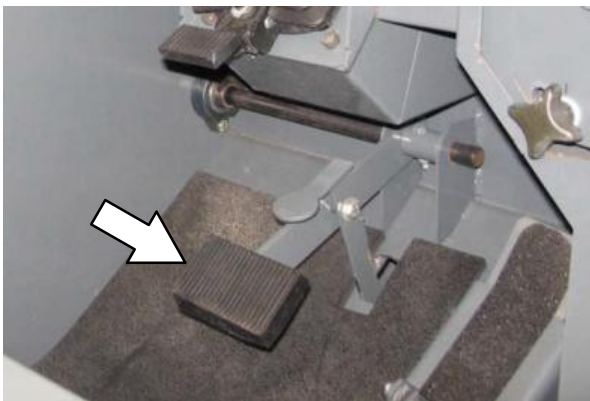

### PARKING BRAKE PEDAL

Press the *Brake pedal* down as far as possible and use toe to lock the *Parking brake pedal* into place. Press the *Brake pedal* to release the parking brake. The *Parking brake pedal* will return to the unlocked position.

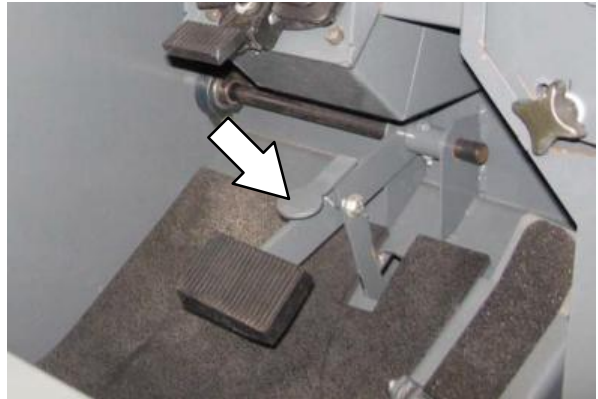

### STEERING COLUMN TILT PEDAL

1. Step on the *Steering column tilt pedal* and adjust the steering column to the desired position.
2. Release the *Steering column tilt pedal* to lock in place.

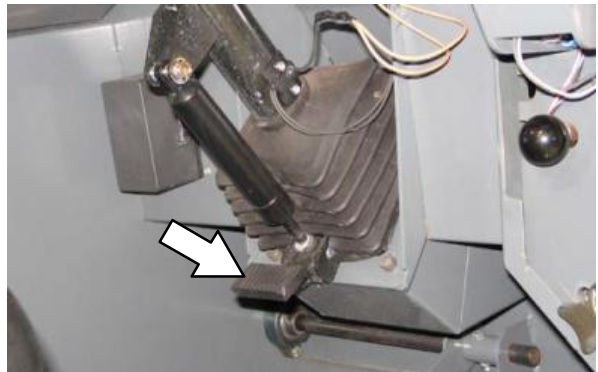

**FUEL GAUGE**

The *Fuel indicator* displays the amount of fuel left in the tank. The fuel level fault indicator will illuminate when the fuel tank is near empty. Refer to *DISPLAY MODULE FAULT INDICATOR(S)*.

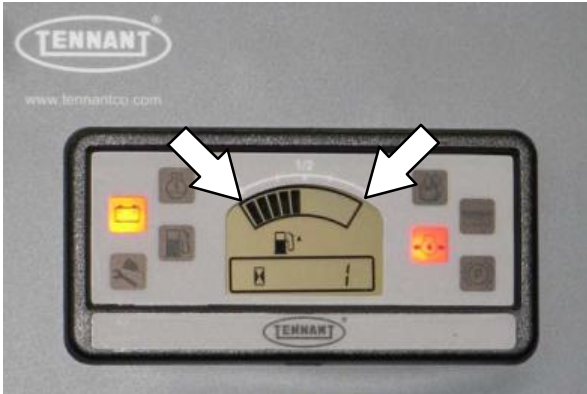
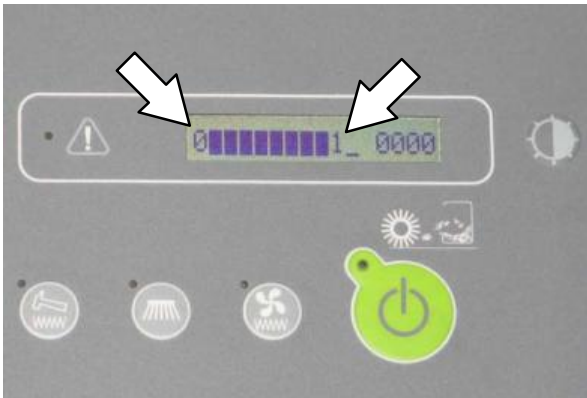
**S30****S30 XP and X4**



# OPERATION

## HOUR METER

The *Hour meter* records the hours the machine was operated. Use this information to determine machine service intervals.



S30

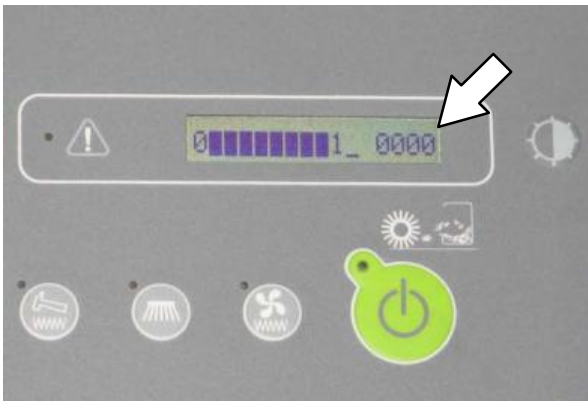

S30 XP and X4

## SUPERVISOR CONTROL BUTTONS (S30 XP and X4)

The *Supervisor Control buttons* are for accessing the configuration and diagnostic modes. Only properly trained service personnel and TENNANT representatives should access these modes.

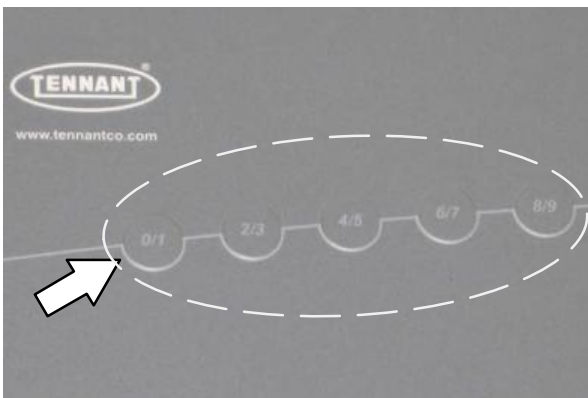

## ENGINE SPEED CONTROLS

Idle Speed: This speed is for starting the machine.

*NOTE: S30 XP and X4 machines automatically start in idle speed.*

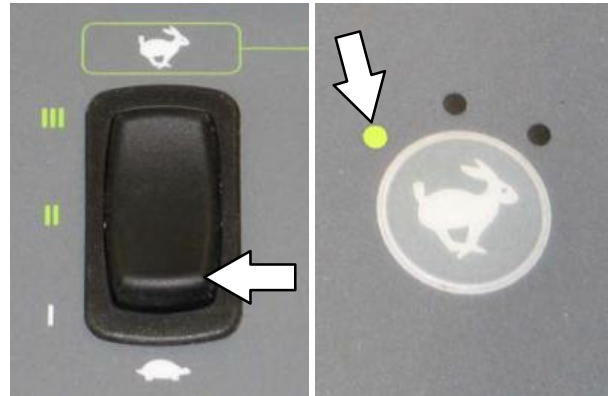

S30

S30 XP and X4

Medium (Fast 1) Speed: This speed is for general sweeping.

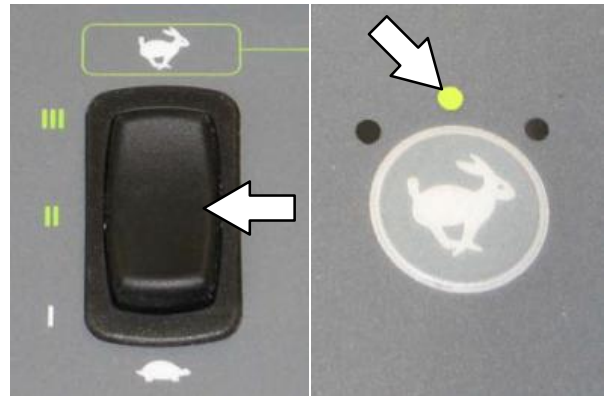

S30

S30 XP and X4

High (Fast 2) Speed: This speed is for sweeping light litter or moving quickly between areas.

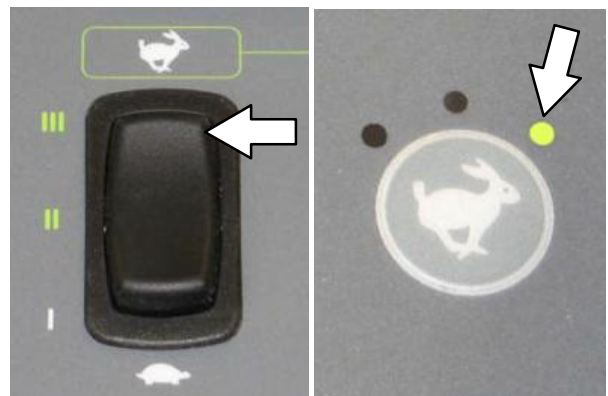

S30

S30 XP and X4

**VACUUM FAN CONTROLS (S30)**

The vacuum fan automatically comes on when the main brush is lowered with the *Vacuum fan switch* in the automatic/on position.

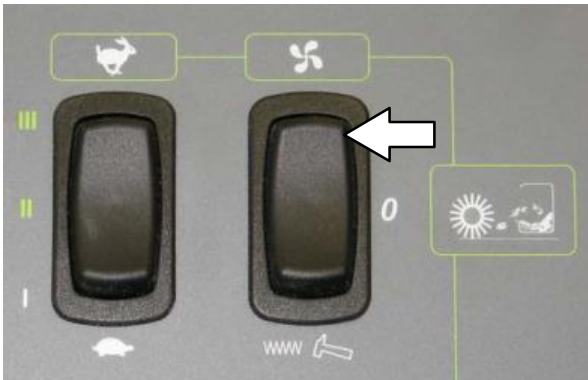

**NOTE:** Turn off the vacuum fan when sweeping over large wet areas or standing water. This prevents the dust filter from getting wet while sweeping.

Press the *Vacuum fan switch* to the middle position to shut off the vacuum fan.

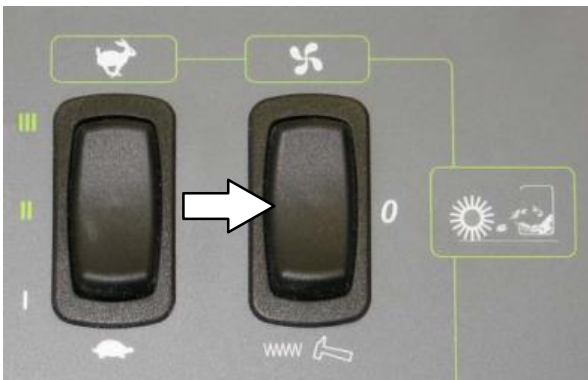

**VACUUM FAN CONTROLS (S30 XP and X4)**

The vacuum fan automatically comes on when the *1-STEP Sweep button* is activated. The light next to the *Vacuum fan button* will come on.

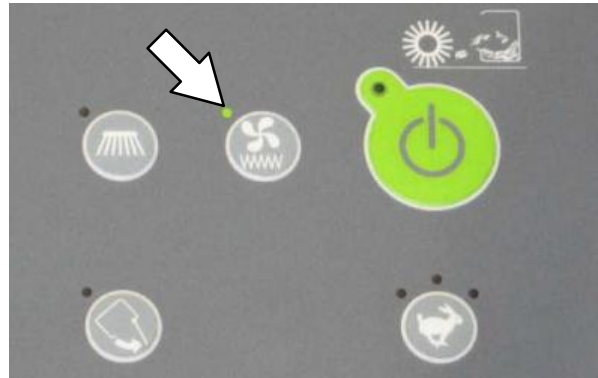

**NOTE:** Turn off the vacuum fan when sweeping over large wet areas or standing water. This prevents the dust filter from getting wet while sweeping.

Press the *Vacuum fan button* to shut off the vacuum fan. The light next to the button will go out.



**CONTRAST CONTROL BUTTON (S30 XP and X4)**

Press and hold the *Contrast control button* to darken/lighten the LCD display.



## OPERATION

### FILTER SHAKER CONTROL (S30)

Press the *Filter shaker switch*. The filter shaker will operate for 30 seconds.

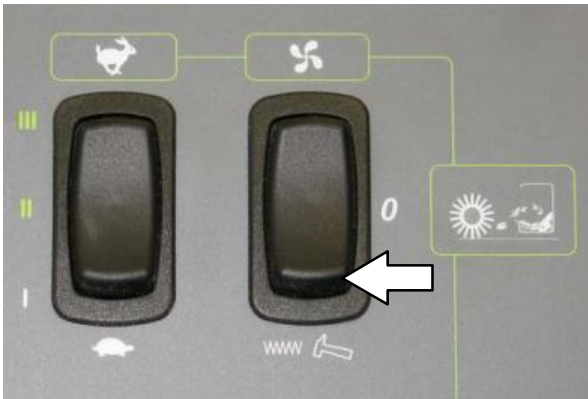

### FILTER SHAKER CONTROL (S30 XP and X4)

The filter shaker automatically activates for about 30 seconds when the *1-STEP Sweep button* is turned off.

Press the filter shaker switch to manually start the 30 second shaker cycle or to stop the shaker cycle.

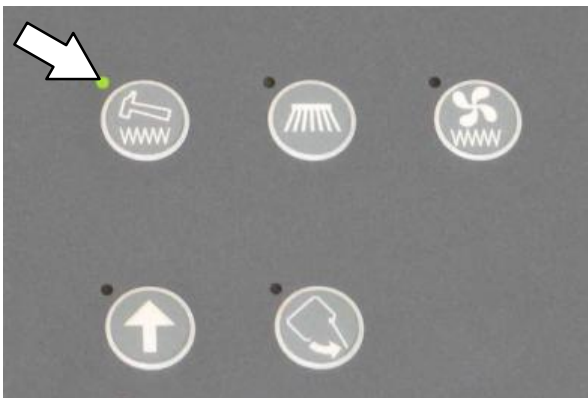

### OPERATING / HAZARD LIGHT SWITCH

Operating and Hazard Lights On: Press the top of the *Operating / hazard light switch*.

Operating Lights On: Press the *Operating / hazard light switch* to the middle position.

All Lights Off: Press the bottom of the *Operating / hazard light switch*.

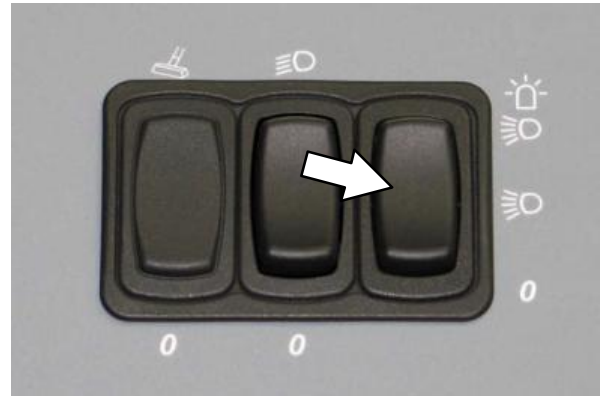

### SIDE BRUSH LIGHT SWITCH (OPTION)

Side Brush Lights On: Press the top of the *Side brush light switch* to turn the side brush light on.

Side Brush Lights Off: Press the bottom of the *Side brush light switch* to turn the side brush light off.

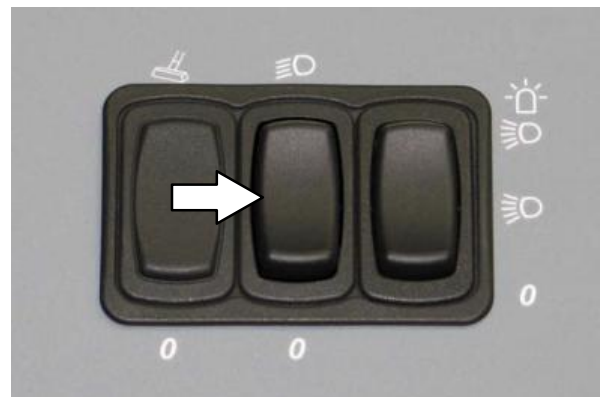



**HOPPER ACCESS DOOR**

Use the hopper access door to dispose of debris too large to be picked up by the machine while sweeping.

Twist the hopper access door handle to loosen the lock, lift the handle to disengage the lock, and then lift the hopper access door open.  
(SN 000000 – 006500)

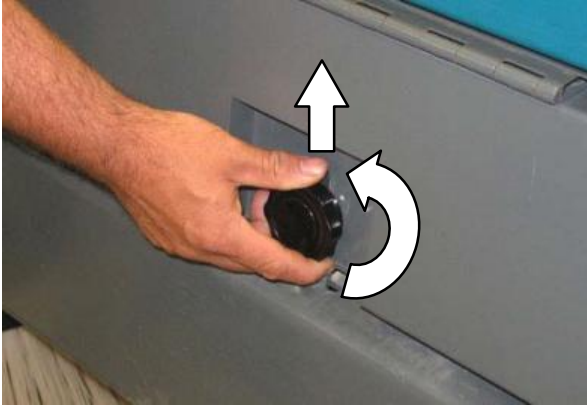

Pull the hopper access door handle to open the hopper access door. (SN 006501 – )



## OPERATION

### OPERATOR SEAT

The front-to-back adjustment lever adjusts the seat position.



The weight adjustment knob controls the firmness of the operator seat. Use the gauge next to the weight adjustment knob to help determine seat firmness.



### DELUXE SUSPENSION SEAT

The operator seat has three adjustments: backrest angle, operator weight, and front to back.

The backrest adjustment knob adjusts the angle of the backrest.



The front-to-back adjustment lever adjusts the seat position.

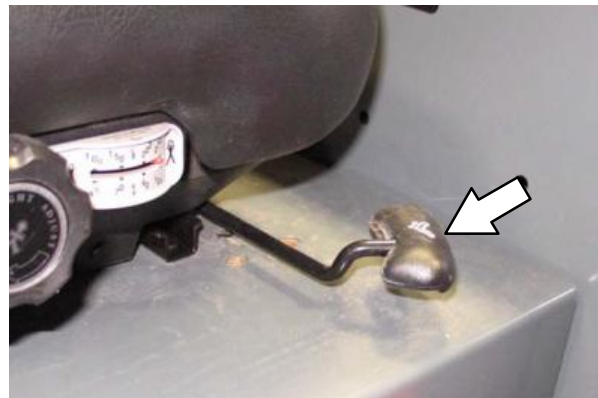

### SEAT BELTS

**FOR SAFETY:** Before starting machine, adjust seat and fasten seat belt (if equipped).



## BRUSH INFORMATION

For best results, use the correct brush type for the cleaning application.

*NOTE: The amount and type of soilage play an important role in determining the type of brushes to use. Contact a Tennant representative for specific recommendations.*

**Polypropylene and Wire 8-double row Main Brush** – Recommended for general sweeping, fine dust, and slightly impacted debris.

**Polypropylene Sand Wedge Main Brush** – Recommended for heavy accumulation of sand and other small particulates.

**Polypropylene Window Main Brush** – Recommended for light litter, especially on smooth floors.

**Polypropylene 8-double row Main Brush** – Recommended for lighter duty sweeping applications.

**Nylon 8-double row Main Brush** – Recommended for general sweeping, especially on rough or irregular surfaces. Nylon has a long wear life.

**Nylon Full Fill Main Brush** – Recommended for accumulation of sand and other small particulates. Nylon has a long wear life.

**Nylon Patrol Main Brush** – Recommended for bulky debris swept at faster speeds.

**Wire 8-double row Main Brush** – Recommended for general sweeping and slightly impacted debris.

**Natural Fiber and Full Fill Main Brush** – Recommended for accumulation of sand and other small particulates.

**Polypropylene Side Brush** – Recommended for general sweeping of light to medium debris.

**Nylon Side Brush** – Recommended for general sweeping of rough or irregular surfaces. Nylon has a long wear life.

**Flat Wire Side Brush** – Recommended for outdoor curb-side sweeping where dirt is heavy or compacted.

## HOW THE MACHINE WORKS

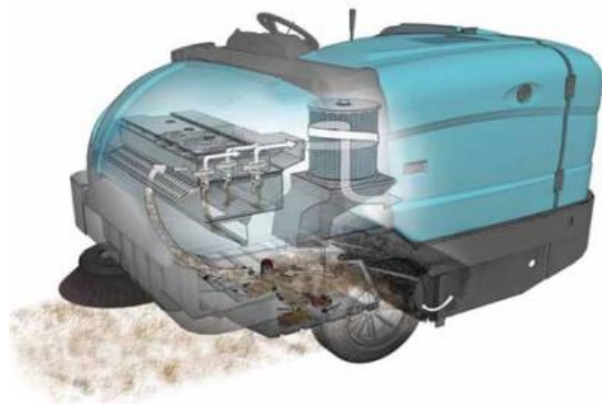

**Machines SN 000000 – 006500**



**Machines SN 006501 –**

The steering wheel controls the direction of machine travel. The directional pedal controls the speed and forward/reverse direction. The brake pedal slows and stops the machine.

The side brush sweeps debris into the path of the main brush. The main brush sweeps debris from the floor into the hopper. The vacuum system pulls dust and air through the hopper and the dust control system.

When sweeping is finished, shake the dust filter and empty the hopper.

### PRE-OPERATION CHECKLIST

---

- Check the fuel level.
- Check the machine for fluid leaks.
- Check the condition of the main brushes.  
Remove string, banding, plastic wrap, or other debris wrapped around the brushes.
- Check the main brush compartment right skirts and seals for damage and wear.
- Side Brush(es): Check the condition of the brush. Remove string, banding, plastic wrap, or other debris wrapped around the brush.
- Check the condition of the debris deflection skirts.
- Check the hydraulic fluid level.
- Check the main brush compartment left skirts and seals for damage and wear.
- Check the engine coolant level.
- Check the engine oil level.
- Check the radiator and hydraulic cooler fins for debris.
- Check the horn, headlights, taillights, safety lights, and backup alarm (if equipped).
- Check the brakes and steering for proper operation.
- Check the service records to determine maintenance requirements.

## STARTING THE MACHINE

1. Sit in the operator seat and press the brake pedal or set the parking brake.

**FOR SAFETY: When starting machine, keep foot on brake and directional pedal in neutral.**

2. **S30:** Place the *Engine speed switch* into the idle position.

**S30 XP and X4:** The engine will automatically start in the idle speed.

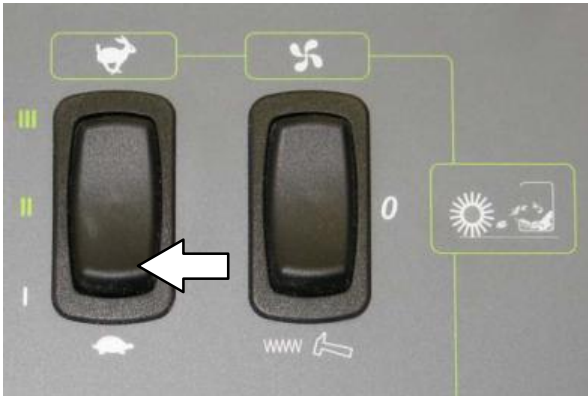

3. Turn the key clockwise until the *glow plug light* comes on, but not far enough to start the engine. Hold the key in this position for 15 to 30 seconds, depending on temperature. Colder temperatures require longer time.

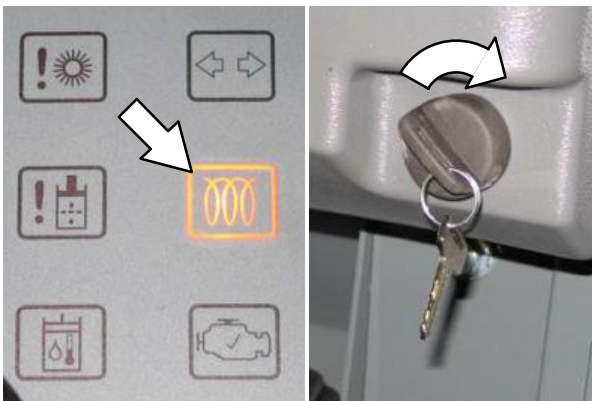

4. Turn the key further clockwise to start the engine.

**NOTE:** Do not operate the starter motor for more than 10 seconds at a time or after the engine has started. Allow the starter to cool 15–20 seconds between starting attempts or damage to the starter motor may occur.

5. Allow the engine and hydraulic system to warm up for three to five minutes.

**WARNING: Machine emits toxic gases. Severe respiratory damage or asphyxiation can result. Provide adequate ventilation. Consult with your regulatory authorities for exposure limits. Keep engine properly tuned.**

6. Turn on lights.

## TURNING OFF THE MACHINE

1. Stop the machine and turn off all sweeping functions.
2. Turn the ignition switch key counter clockwise to turn off the machine. Remain in the operator seat until the engine is off.

**FOR SAFETY: Before leaving or servicing machine, do not park near combustible materials, dust, gases, or liquids. Stop on level surface, set parking brake, turn off machine, and remove key.**

### WHILE OPERATING THE MACHINE

---

Pick up oversized debris before sweeping. Pick up wire, string, twine, large pieces of wood, or any other debris that could become wrapped around or tangled in the brushes.

Drive as straight a path as possible. Avoid bumping into posts or scraping the sides of the machine. Overlap the sweep paths by several centimeters (a few inches).

Avoid turning the steering wheel too sharply when the machine is in motion. The machine is very responsive to the movement of the steering wheel. Avoid sudden turns, except in emergencies.

Adjust the machine speed and brush pressure. Use the lowest brush pressure for best performance.

Keep the machine moving to prevent damaging floor finishes.

If poor cleaning performance is observed, stop cleaning and refer to *MACHINE TROUBLESHOOTING* in this manual.

Perform the Daily Maintenance Procedures after each use (see *MACHINE MAINTENANCE* in this manual).

Drive the machine slowly on inclines. Use the brake pedal to control machine speed on descending inclines. Allow more braking distance when traveling at faster speeds. Sweep with the machine up inclines rather than down inclines.

**FOR SAFETY: When using machine, go slowly on inclines and slippery surfaces.**

Do not operate machine in areas where the ambient temperature is above 43° C (110° F). Do not operate sweeping functions in areas where the ambient temperature is below freezing 0° C (32° F). With the proper hydraulic fluid and a machine warm-up period, the machine is capable of operating at much lower temperatures.

**FOR SAFETY: Do not sweep on ramp inclines that exceed 14% grade or transport (GVWR) on ramp inclines that exceed 17% grade.**



## SWEEPING (S30)

**FOR SAFETY: Do not operate machine, unless operator manual is read and understood.**

1. Start the machine.
2. Ensure the hopper is completely lowered.
3. Ensure the *vacuum fan switch* is in the automatic/on position.

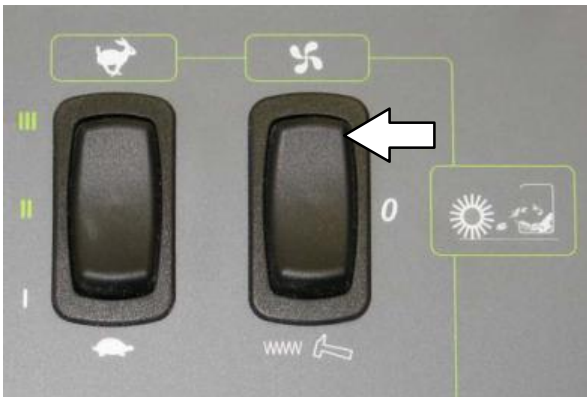

4. Ensure the *hopper door switch* is in the upper automatic position.



5. Select an engine speed. Use medium speed for general sweeping and high speed for sweeping light litter.



6. Lower the brushes.

**NOTE:** The brushes will rotate, the hopper door will open, and the vacuum fan will come on.

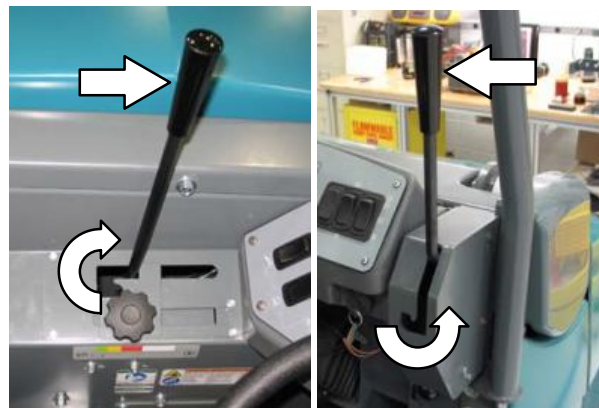

7. Release the *parking brake*, then press the *Directional pedal* to begin sweeping.

**FOR SAFETY: When using machine, go slow on inclines and slippery surfaces.**

**NOTE:** Turn off the vacuum fan when sweeping over large wet areas or standing water. This prevents the dust filter from getting wet while sweeping.

## OPERATION

- To stop sweeping, press the *Brake pedal* to stop the machine.
- Raise the brushes.

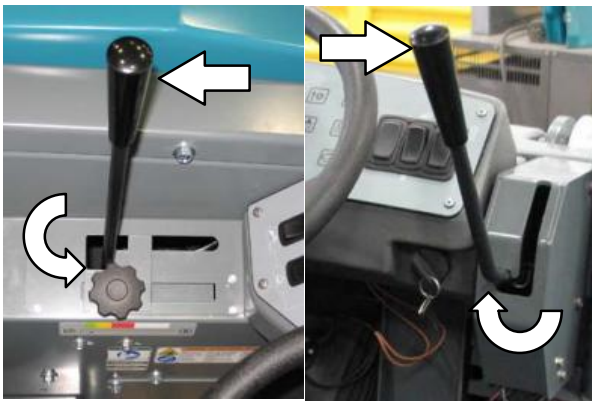

- Press the *filter shaker switch* to activate the hopper filter shaker. It will operate for about 30 seconds.

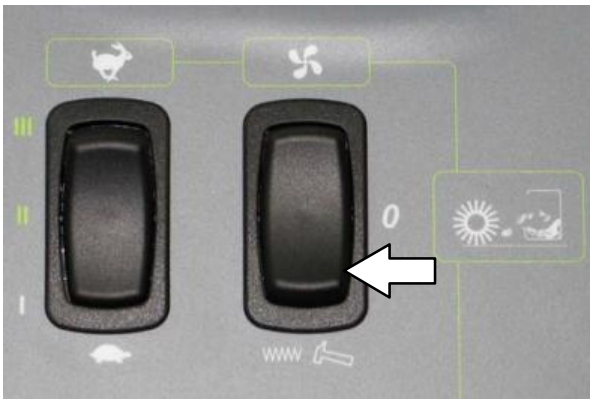

- Empty the debris hopper at the end of each shift or as needed. See *EMPTYING THE HOPPER* section of this manual.

## SWEEPING (S30 XP and X4)

**FOR SAFETY: Do not operate machine, unless operator manual is read and understood.**

- Start the machine.

*NOTE: Make sure the sweep modes / settings are set before sweeping.*

- Press the *1-STEP Sweep button*. All the preset sweeping functions will turn on. The light on the button will come on.

*NOTE: The engine idle speed will increase, the brushes will rotate, the hopper door will open, and the vacuum fan will come on. Adjust the engine idle speed as needed.*



- Release the parking brake, then press the *Directional pedal* to begin sweeping.

**FOR SAFETY: When using machine, go slow on inclines and slippery surfaces.**

*NOTE: Turn off the vacuum fan when sweeping over large wet areas or standing water. This prevents the hopper dust filter from getting wet while sweeping.*

- To stop sweeping, press the *Brake pedal* to stop the machine.
- Press the *1-STEP Sweep button*. The light on the button will turn off. All the preset sweeping functions will turn off and the automatic filter shaker will operate for about 30 seconds.
- Empty the debris hopper at the end of each shift or as needed. See *EMPTYING THE HOPPER* section of this manual.



**EMPTYING THE HOPPER**

1. Slowly drive the machine to the debris site or debris container.
2. Stop the sweeping functions.
3. Press and hold the *Hopper raise switch or button* to raise the hopper.

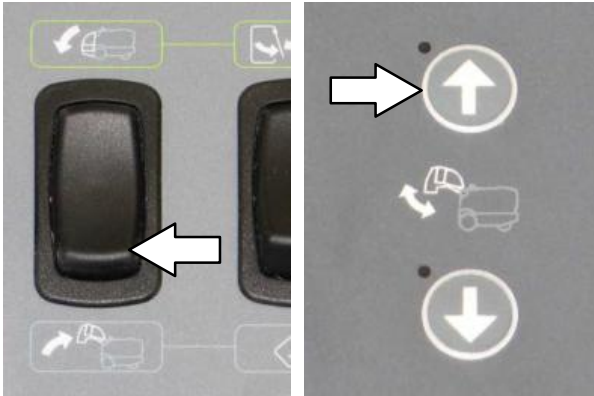

**S30**

**S30 XP and X4**

**FOR SAFETY:** When using machine, make sure adequate clearance is available before raising hopper. Do not raise hopper when machine is on an incline.

*NOTE:* Be aware the minimum ceiling height needed to raise the hopper is 2500 mm (98 in).

4. Slowly drive the machine up to the debris container.

**FOR SAFETY:** When using machine, use care when reversing machine. Move machine with care when hopper is raised.

5. Lower the hopper into the debris container to control dust.

*NOTE:* To prevent damaging the machine, DO NOT hit the debris container with the machine.

6. Open the hopper door to empty the hopper.

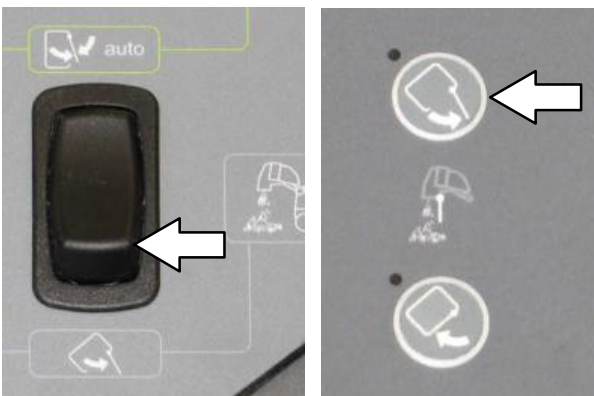

**S30**

**S30 XP and X4**

7. **S30:** Place the *Hopper door switch* in the automatic position to close the hopper door.

**S30 XP and X4:** Press the *Hopper door close button* to close the hopper door.



**S30**

**S30 XP and X4**

8. Raise the hopper enough to clear the top of the debris container.
9. Slowly back the machine away from the debris site or debris container.
10. Press and hold the *Hopper lower switch or button* to completely lower the hopper.

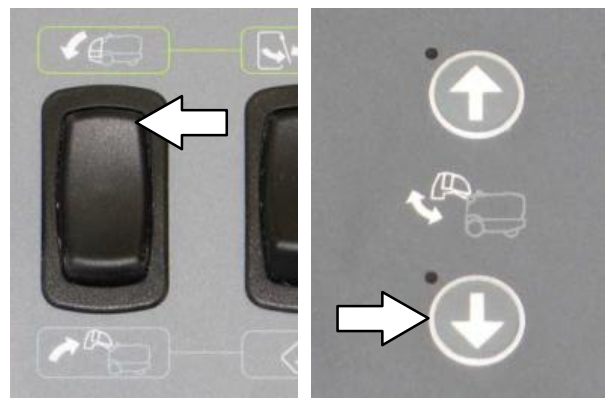

**S30**

**S30 XP and X4**

# OPERATION

## ENGAGING THE HOPPER SUPPORT BAR

The hopper support bar prevents the raised hopper from falling. Always engage the hopper support bar whenever leaving the hopper in the raised position.

1. Set the parking brake.
2. Start the machine.
3. Completely raise the hopper.

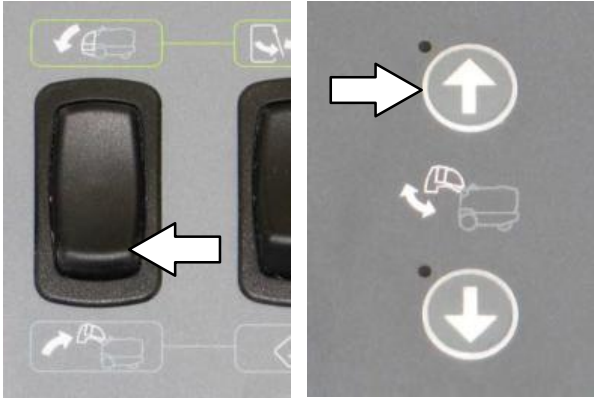

S30

S30 XP and X4

**WARNING:** Lift arm pinch point. Stay clear of hopper lift arms.

**FOR SAFETY:** When using machine, make sure adequate clearance is available before raising hopper.

4. Rotate the support bar down into the hopper support clip.

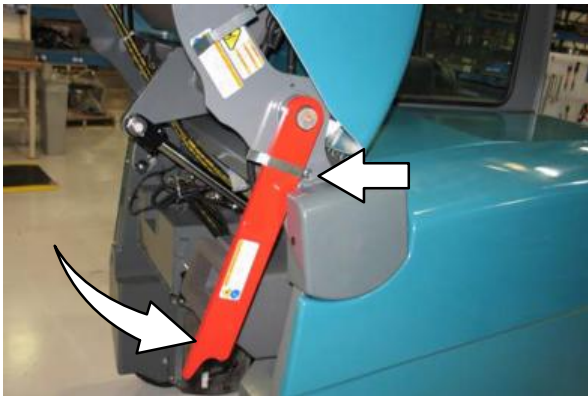

**WARNING:** Raised hopper may fall. Engage hopper support bar.

5. Lower the hopper to lower the hopper support bar onto the bracket.

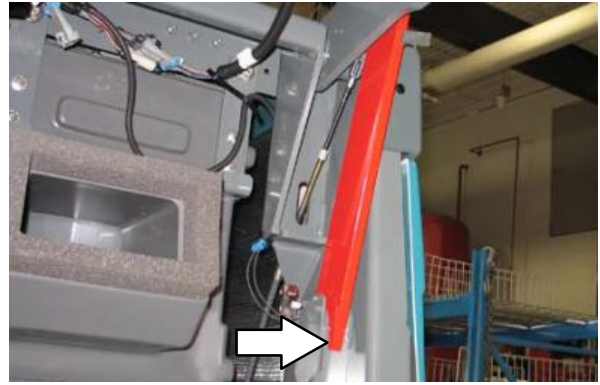

6. Turn off the machine.

## DISENGAGING THE HOPPER SUPPORT BAR

1. Start the machine.
2. Completely raise the hopper.

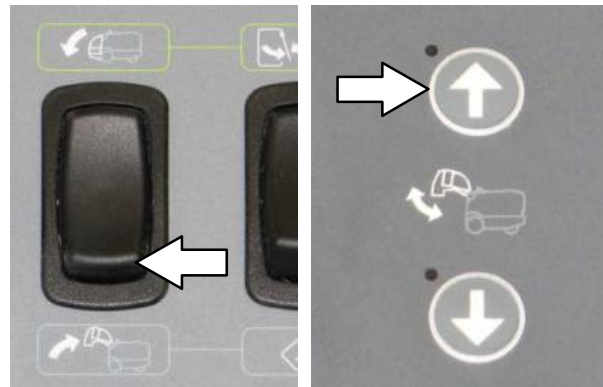

S30

S30 XP and X4

3. Set the parking brake.
4. Rotate the hopper support bar up into the storage clip.

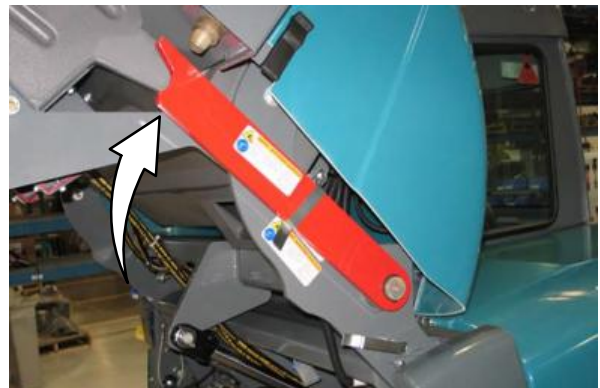

5. Completely lower the hopper.

**WARNING:** Lift arm pinch point. Stay clear of hopper lift arms.

**DISPLAY MODULE FAULT INDICATORS (S30)**

The *fault indicator lights* illuminate when a fault has occurred. Stop the machine immediately and correct the problem if these indicators come on.

Refer to the table below to determine the cause and remedy for the fault.

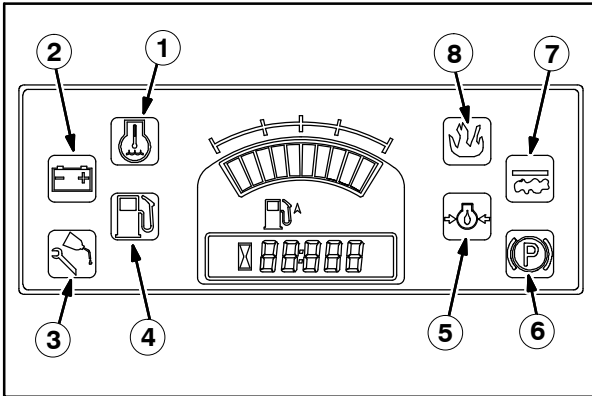

<b>Fault Indicators</b>	<b>Cause(s)</b>	<b>Remedy</b>
1: Water Temperature (Red)	Engine coolant is too hot to safely operate the machine	Shut off machine. Contact TENNANT service representative.
2: Charging System (Amber)	Alternator is not charging the battery.	Shut off machine. Contact TENNANT service representative.
3: Maintenance (Amber)	Not Used	Not Used
4: Fuel Level (Red)	Fuel level is low.	Refuel / Change fuel tank
5: Engine Oil Pressure (Red)	Oil pressure is below the normal operating pressure	Shut off machine. Contact TENNANT service representative.
6: Parking Brake (Amber)	Not Used	Not Used
7: Clogged Dust Filter (Amber)	Dust filter is clogged	Activate the filter shaker.
8: Hopper Fire (Red)	Fire in the hopper	Shut off machine. Extinguish fire. If necessary, call emergency personnel.

## OPERATION

### FAULT INDICATOR(S) (S30 XP and X4)

This machine is equipped with two visual indicators, a red indicator light and an LCD (liquid crystal display).

The red indicator light will blink continuously indicating that a fault has occurred.

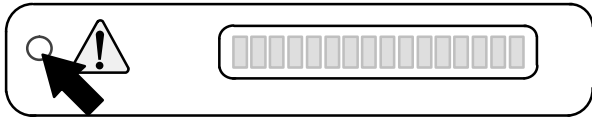

The LCD will display a fault code. If there is more than one fault, each fault will alternately display.



All faults are also accompanied by an audible alarm to alert the operator a fault has occurred.

Refer to the table below to determine the cause and remedy for the fault.

Fault Code (Displayed in LCD)	Cause(s)	Result	Remedy
F3: CLOGGED HYD FILTER	Hydraulic filter is clogged	-	Shut off machine. Contact TENNANT service representative.
F4: SHAKER FILTER	Hopper dust filter is clogged	-	Activate filter shaker to unclog hopper dust filter.
F5: HOPPER FIRE	Fire in the hopper	Terminates sweeping functions and closes hopper door	Shut off machine. Extinguish fire. If necessary, call emergency personnel.
F6: ALTERNATOR	Alternator not charging	-	Contact TENNANT service representative.
F7: LOW OIL PRESS	Engine oil pressure is low	Shuts down engine	Contact TENNANT service representative.
F8: HIGH ENG TEMP	Engine temperature is high	Shuts down engine	Shut off machine. Contact TENNANT service representative.
F9: HIGH HYD TEMP	Hydraulic fluid temperature is high	Cancels 1-Step sweep functions	Shut off machine. Contact TENNANT service representative.
F10: LOW FUEL	Low fuel	-	Fill fuel tank.
F18: HOPPER UP	Hopper is up	Terminates sweeping functions-	Lower hopper completely.
F20: UP KEY ERR	Hopper up button failure	Prevents all panel operations	Shut off machine. Contact TENNANT service representative.
F21: DN KEY ERR	Hopper down button failure	Prevents all panel operations	Shut off machine. Contact TENNANT service representative.
F22: OPN KEY ERR	Hopper door open button failure	Prevents all panel operations	Shut off machine. Contact TENNANT service representative.
F23: CL KEY ERR	Hopper door close button failure	Prevents all panel operations	Shut off machine. Contact TENNANT service representative.
F24: SEAT SWITCH (Option)	Operator not in the seat while engine is running and parking brake not engaged	Engine will shut off	Engage parking brake before leaving the machine.

**DASH FAULT INDICATORS**

The *dash fault indicators* illuminate when a fault has occurred. Stop the machine immediately and correct the problem if these indicators come on.

Refer to the table below to determine the cause and remedy for the fault.

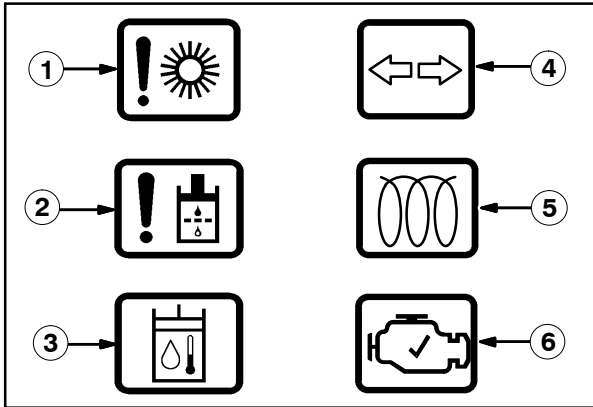

<b>Warning Light</b>	<b>Cause(s)</b>	<b>Remedy</b>
1: Stalled Brush	One of the brushes is stalled	Shut off machine and remove obstructions preventing brushes from operating
2: Hydraulic Filter	Hydraulic filter is clogged	Shut off machine. Contact TENNANT service representative
3: Hydraulic Temperature	Hydraulic system is too hot to safely operate the machine	Shut off machine. Contact TENNANT service representative
4: Hazard Flasher	Not Used	Not Used
5: Glow Plug – Preheat	This comes on when the ignition switch is turned to the preheat position	This goes out immediately after engine is started
6: Check Engine	Engine control system detects a fault during machine operation	Shut off machine. Contact TENNANT service representative

## OPTIONS

### WAND (OPTION)

The *vacuum wand* allows the operator to pick-up debris that is out of reach of the machine's sweeping path. The *blower wand* allows the operator to blow debris out from areas that are out of reach of the machine's sweeping path.

**WARNING: Accident may occur. Do not operate vacuum or blower wand while driving.**

1. Raise the brushes.
2. Stop the machine and turn off the engine.

**FOR SAFETY: Before leaving or servicing machine, stop on level surface, set parking brake, turn off machine, and remove key.**

3. Connect the hose assembly to the wand.
4. Attach the *vacuum wand* hose to the machine under the vacuum wand door located on the front of the hopper. Make sure the hopper door is closed when operating the vacuum wand.

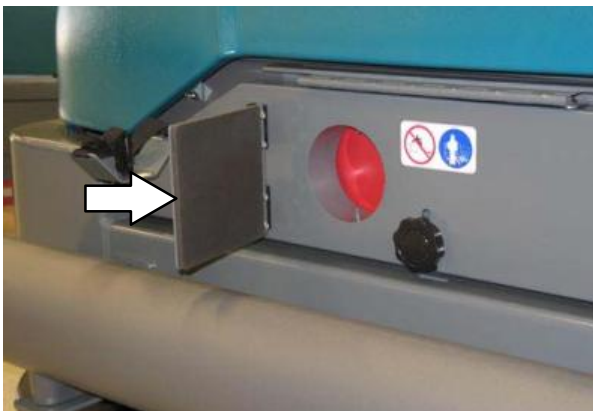

5. Attach the *blower wand* hose to the machine under the blower wand door located on the left side of the machine. Make sure the hopper door is open when operating the blower wand.

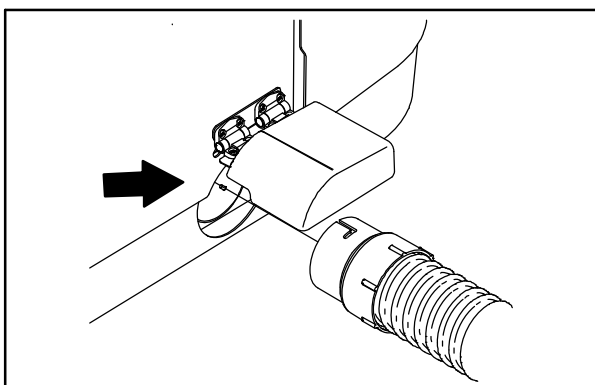

6. Start the machine.



**WARNING: Machine emits toxic gases. Severe respiratory damage or asphyxiation can result. Provide adequate ventilation. Consult with your regulatory authorities for exposure limits. Keep engine properly tuned.**

7. **S30:** Press the *Wand switch* to start the vacuum fan. Then set the engine to high speed.

**S30 XP and X4:** Press the *Vacuum fan button* to start the vacuum fan. The engine will automatically set to the high speed.

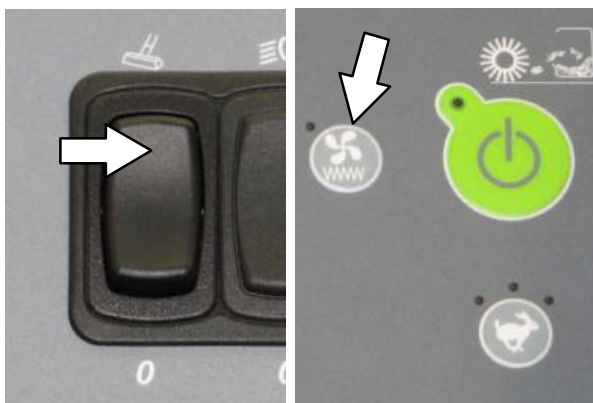

S30

S30 XP and X4

8. Clean the area as needed.
9. **S30:** Press the *Wand switch* to shut off the vacuum fan. Then set the engine to idle speed.

**S30 XP and X4:** Press the *Vacuum fan button* to shut off the vacuum fan. Then set the engine to idle speed.

10. Shut the machine off.
11. Disconnect the wand from the machine and return it to the storage location.



**HEATER / AIR CONDITIONER CONTROLS (OPTION)**

Use the *Heater / Air conditioner switch* to turn on the heater or air conditioner.

Top position: Air conditioner

Middle position: Off

Bottom position: Heater



Use the *Temperature knob* to control the cab heater temperature. Use the *Fan knob* to control the air conditioner temperature.



Use the *Fan knob* to control the fan speed. This knob affects the heater and air conditioner.

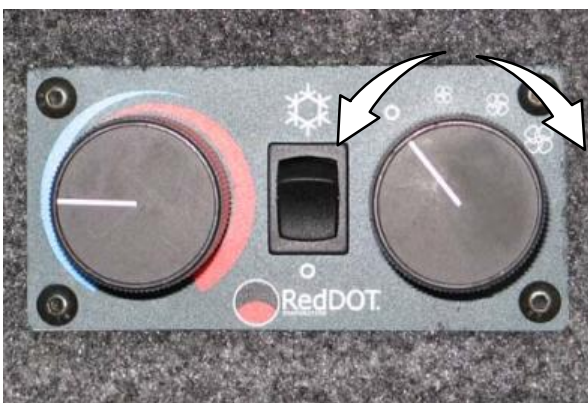

**WINDSHIELD WIPER SWITCH (OPTION)**

Use the *Windshield wiper switch* to turn on and adjust the windshield wiper speed.

Top position: High

Middle position: Low

Bottom position: Off

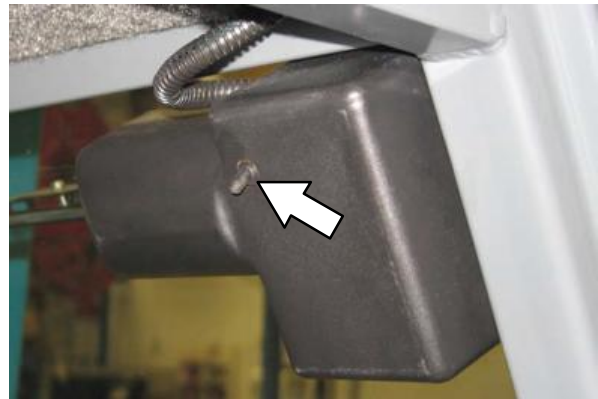

**CAB LIGHT SWITCH (OPTION)**

Press the *Cab light switch* to operate the cab light.



## OPERATION

### TOWER BUMPERS (OPTION)

The tower bumpers help protect the rear engine cover from being damaged if the machine is backed into an obstruction. Open the tower bumpers before opening rear engine shroud.

To open the bumpers:

1. Pull the pin from the bracket and the bumper.



2. Open the bumper.

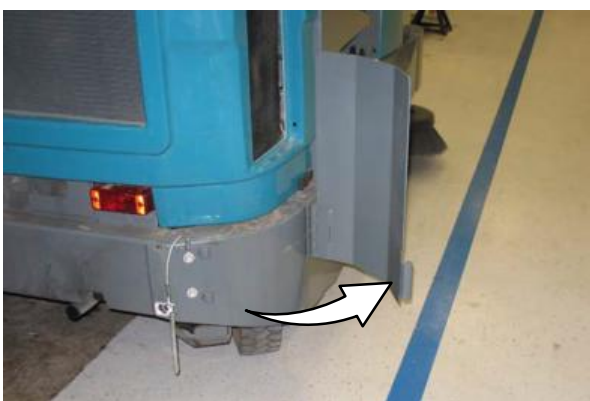

3. Close and secure the tower bumpers before operating the machine.



## MACHINE TROUBLESHOOTING

Problem	Cause	Remedy	
Excessive dusting	Brush skirts and dust seals worn, damaged, out of adjustment	Replace or adjust brush skirts or dust seals	
	Dust filter clogged	Shake and/or replace dust filter	
	Cyclones dirty / clogged	Clear blockage from cyclones	
	Vacuum hose damaged	Replace vacuum hose	
	Vacuum fan seal damaged	Replace vacuum fan seal	
	Vacuum fan failure		Ensure Thermo Sentry wires are connected
			Call Tennant service representative
	Thermo-Sentry tripped	Allow Thermo-Sentry to cool	
Poor sweeping performance	Worn brush bristles	Replace brushes	
	Brush pressure set too light	Increase brush pressure	
	Main brush not properly adjusted	Adjust brush	
	Debris caught in main brush drive mechanism	Remove debris from main brush drive mechanism	
	Main and/or side brush drive failure	Call Tennant service representative	
	Hopper is full	Empty hopper	
	Hopper lip skirts worn or damaged	Replace lip skirts	
	Improper brushes	Refer to <i>Brush Information</i> or call Tennant service representative	
	Engine speed set wrong	Set engine speed correctly	
Sweeping functions do not turn on	Hopper is up	Completely lower hopper	
	Fire in the hopper	Shut off machine. Extinguish fire. If necessary, call emergency personnel	
	S30 XP and X4: Hydraulic fluid too hot	Call Tennant service representative	

**MAINTENANCE**

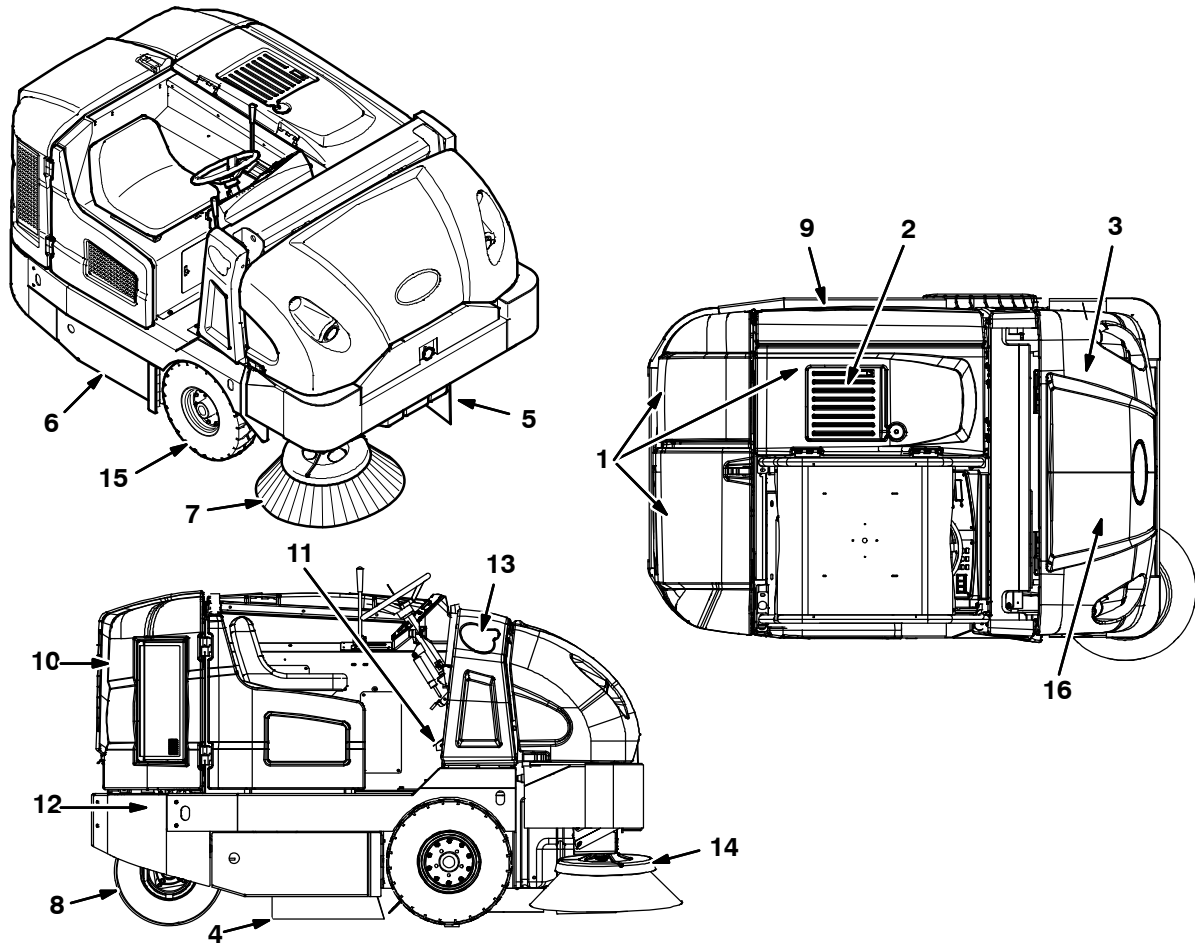

**MAINTENANCE CHART**

The table below indicates the *Person Responsible* for each procedure.

**O = Operator.**

**T = Trained Personnel.**

Interval	Person Resp.	Key	Description	Procedure	Lubricant /Fluid	No. of Service Points
Daily	O	1	Engine	Check oil level	EO	1
				Check coolant level in reservoir	WG	1
				Check air filter indicator	-	1
	O	2	Hydraulic fluid reservoir	Check fluid level	HYDO	1
	O	3	Dust filter	Shake to clean	-	1
	O	4	Main brush compartment skirts	Check for damage, wear, and adjustment	-	All
O	5	Hopper skirts	Check for damage, wear, and adjustment	-	All	

The table below indicates the *Person Responsible* for each procedure.

**O = Operator.**

**T = Trained Personnel.**

Interval	Person Resp.	Key	Description	Procedure	Lubricant /Fluid	No. of Service Points
Daily	O	6	Main brush	Check for damage and wear	–	1
	O	7	Side brush	Check for damage and wear	–	1
50 Hours	O	6	Main brush	Rotate end-for-end	–	1
	T	6	Main brush	Check brush pattern and adjust if needed	–	1
	T	8	Rear wheel	Torque wheel nuts ( <b>after initial 50 hours only</b> )	–	1
	T	9	Battery	Clean and tighten battery cable connections ( <b>after initial 50 hours only</b> )	–	1
	T	1	Engine	Check belt tension	–	1
	T	1	Fuel lines	Check for damage and wear and tighten loose clamp bands	–	1
100 Hours	T	1	Engine	Change oil and filter	EO	1
	T	3	Dust filter	Check for damage, clean or replace	–	1
	T	16	Cyclones / filter housing	Clean	–	All
	T	16	Cyclone seals	Check for damage or wear	–	All
	T	10	Radiator	Clean core exterior	–	1
	T	2	Hydraulic cooler	Clean core exterior	HYDO	1
	O	8	Rear tire	Check pressure	–	1
	O	–	Seals	Check for damage or wear	–	All
200 Hours	T	10	Radiator hoses and clamps	Check for tightness and wear	–	All
	T	11	Brake pedal	Check adjustment	–	1
	T	12	Rear wheel support bearings (S30 and S30 XP)	Lubricate	SPL	2

**NOTE:** Change the hydraulic fluid, filter, and suction strainer, indicated (\*), after every 800 hours for machines NOT originally equipped with **TennantTrue** premium hydraulic fluid. (See Hydraulics section).

**LUBRICANT/FLUID**

EO . . . . 10W–30, 10W–40, or 15W–40 Engine oil, API diesel classification CF or better.

HYDO . **TennantTrue** premium hydraulic fluid or equivalent

WG . . . Water and ethylene glycol anti-freeze, –34° C (–30° F)

SPL . . . Special lubricant, Lubriplate EMB grease (Tennant part number 01433–1)

**NOTE:** More frequent maintenance intervals may be required in extremely dusty conditions.

## MAINTENANCE

The table below indicates the *Person Responsible* for each procedure.

**O = Operator.**

**T = Trained Personnel.**

Interval	Person Resp.	Key	Description	Procedure	Lubricant /Fluid	No. of Service Points
200 Hours	T	12	Steering cylinder bearings (S30 and S30 XP) (S/N 000000 – 006766)	Lubricate	SPL	1
	T	12	Steering spindles (S30 X4)	Lubricate	SPL	2
	T	12	Steering rod (S30 X4)	Lubricate	SPL	1
	T	13	Hopper lift arm bearings	Lubricate	SPL	2
	T	14	Side brush guard	Rotate 90°	–	1
400 Hours	T	1	Engine	Replace fuel filter	–	1
	T	15	Front wheels	Adjust and repack bearings	SPL	2
800 Hours	T	2	Hydraulic fluid reservoir	Replace filler cap	–	1
	T	–	Hydraulic hoses	Check for wear and damage	–	All
	T	10	Cooling system	Flush	WG	1
	T	8	Propelling motor	Torque shaft nut	–	1
	T	8	Rear wheel	Torque wheel nuts	–	1
	T	9	Battery	Clean and tighten battery cable connections	–	1
1200 Hours	T	2	Hydraulic fluid filter	* Change filter element	–	All
2400 Hours	T	2	Hydraulic fluid reservoir	* Replace suction strainer	–	1
				* Change hydraulic fluid	HYDO	1

*NOTE: Change the hydraulic fluid, filter, and suction strainer, indicated (\*), after every 800 hours for machines NOT originally equipped with **TennantTrue** premium hydraulic fluid. (See Hydraulics section).*

### LUBRICANT/FLUID

EO . . . . 10W–30, 10W–40, or 15W–40 Engine oil, API diesel classification CF or better.

HYDO . **TennantTrue** premium hydraulic fluid or equivalent

WG . . . Water and ethylene glycol anti-freeze, –34° C (–30° F)

SPL . . . Special lubricant, Lubriplate EMB grease (Tennant part number 01433–1)

*NOTE: More frequent maintenance intervals may be required in extremely dusty conditions.*

**LUBRICATION**

**FOR SAFETY: Before leaving or servicing machine, stop on level surface, set parking brake, turn off machine, and remove key.**

**ENGINE OIL**

Check the engine oil level daily. Change the oil and oil filter after every 100 hours of operation.



Fill the engine with oil until the oil is between the indicator marks on the dipstick. **DO NOT** fill past the top indicator mark. The engine oil capacity is 6 L (6.35 qt) with oil filter.

**REAR WHEEL SUPPORT (S30 and S30 XP)**

Lubricate the rear wheel support bearings after every 200 hours of operation.

**STEERING CYLINDER BEARING (S30 and S30 XP) (S/N 000000 – 006766)**

Lubricate the steering cylinder after every 200 hours of operation.

**HOPPER LIFT ARM BEARINGS**

Lubricate the hopper lift arm bearings after every 200 hours of operation.



## MAINTENANCE

### STEERING ROD END (S30 X4)

Lubricate the steering rod end and spindles after every 200 hours of operation.



### FRONT WHEEL BEARINGS

Repack and adjust the front wheel bearings every 400 hours of operation.



### STEERING SPINDLES (S30 X4)

Lubricate the steering after every 200 hours of operation.

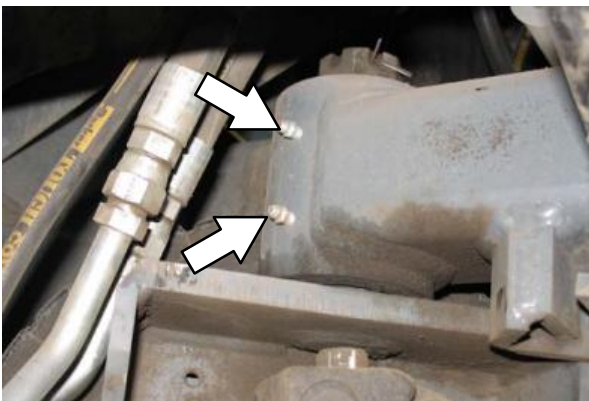
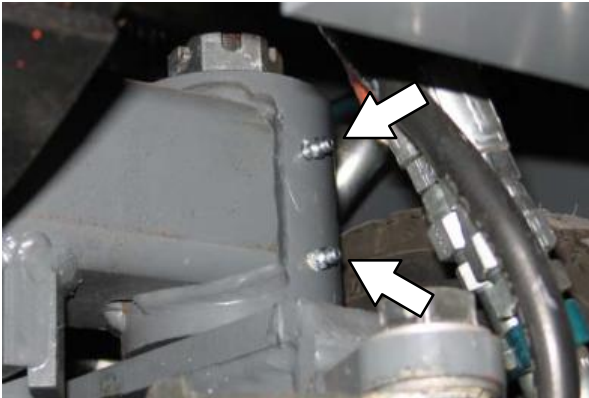



**HYDRAULICS**

**FOR SAFETY: Before leaving or servicing machine, stop on level surface, set parking brake, turn off machine, and remove key.**

Check the hydraulic fluid level at operating temperature daily. The hopper must be down when checking hydraulic fluid level.



A filler cap is mounted on top of the reservoir. It has a built-in breather and fluid level dipstick. Replace the cap after every 800 hours of operation.

Lubricate the filler cap gasket with a film of hydraulic fluid before putting the cap back on the reservoir.

**ATTENTION! Do not overfill the hydraulic fluid reservoir or operate the machine with a low level of hydraulic fluid in the reservoir. Damage to the machine hydraulic system may result.**

Drain and refill the hydraulic fluid reservoir with new **TennantTrue** premium hydraulic fluid after every 2400 hours of operation. Machines have a blue colored drop (left photo) on the hydraulic fluid label if originally equipped with **TennantTrue** premium hydraulic fluid.

**WARNING: Burn hazard. Hot surface. Do NOT touch.**

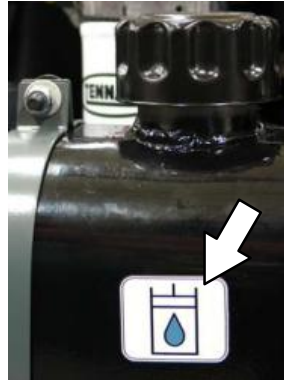

**TennantTrue Fluid**



**Previous Fluid**

*NOTE: Change the hydraulic fluid, filter, and suction strainer after every 800 hours for ALL machines that have NOT consistently used **TennantTrue** premium hydraulic fluid or equivalent.*

The reservoir has a built-in strainer outlet that filters hydraulic fluid before it enters the system. Replace the strainer after every 2400 hours of operation.

Replace the hydraulic fluid filter after every 1200 hours of operation or if the hydraulic reservoir gauge is in the yellow/red zone when the reservoir hydraulic fluid is approximately 32°C (90° F).



# MAINTENANCE

## HYDRAULIC FLUID

There are three fluids available for different temperature ranges:

TennantTrue premium hydraulic fluid (Extended Life)			
Part Number	Capacity	ISO Grade Viscosity Index (VI)	Ambient Air Temperature Ranges
1057710	3.8 L (1 gal)	ISO 100 VI 126 or higher	19° C (65° F) or higher
1057711	19 L (5 gal)		
1069019	3.8 L (1 gal)	ISO 68 VI 155 or higher	7 to 43° C (45 to 110° F)
1069020	19 L (5 gal)		
1057707	3.8 L (1 gal)	ISO 32 VI 163 or higher	16° C (60° F) or lower
1057708	19 L (5 gal)		

If using a locally-available hydraulic fluid, be sure the specifications match Tennant hydraulic fluid specifications. Substitute fluids can cause premature failure of hydraulic components.

**ATTENTION!** Hydraulic components depend on system hydraulic fluid for internal lubrication. Malfunctions, accelerated wear, and damage will result if dirt or other contaminants enter the hydraulic system.

## HYDRAULIC HOSES

Check the hydraulic hoses after every 800 hours of operation for wear or damage.

**FOR SAFETY: When servicing machine, use cardboard to locate leaking hydraulic fluid under pressure.**

High pressure fluid escaping from a very small hole can almost be invisible, and can cause injury.

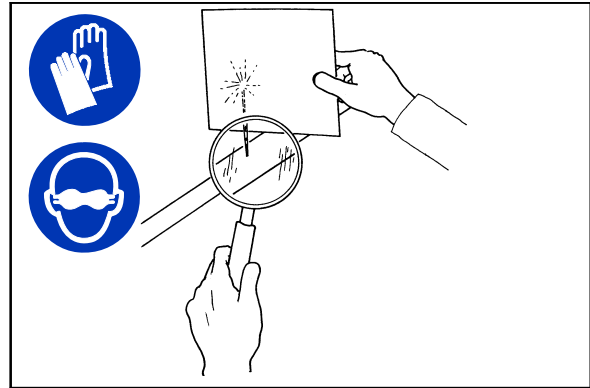

00002

Contact appropriate personnel if a leak is discovered.

**ATTENTION: Only use TENNANT supplied hydraulic hoses or equivalent rated hydraulic hoses.**



**ENGINE**

**FOR SAFETY: Before leaving or servicing machine, stop on level surface, set parking brake, turn off machine, and remove key.**

**COOLING SYSTEM**

**FOR SAFETY: When servicing machine, avoid contact with hot engine coolant. Do not remove cap from radiator when engine is hot. Allow engine to cool.**

Check the coolant level in the reservoir daily. The coolant level must be between the indicator marks when the engine is cold.



**FOR SAFETY: When servicing machine, do not remove cap from radiator when engine is hot. Allow engine to cool.**

Refer to the coolant manufacturer for water/coolant mixing instructions.

Flush the radiator and the cooling system after every 800 hours of operation.

The cooling system must be completely filled with coolant to keep the engine from overheating. When filling the cooling system, open the drain cocks to bleed the air from the system.

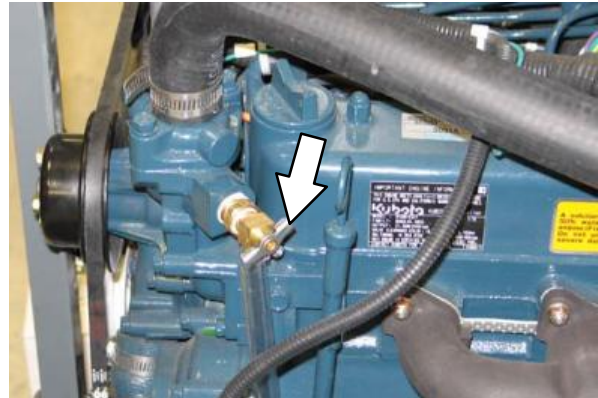

Check the radiator hoses and clamps after every 200 hours of operation. Tighten loose clamps. Replace damaged hoses and clamps.



Check the radiator core exterior and hydraulic cooler fins for debris after every 100 hours of operation. Blow or rinse (with low pressure air or water) all dust through the grille and radiator fins, in the opposite direction of normal air flow. Be careful to not bend the cooling fins when cleaning. Clean thoroughly to prevent the fins from becoming encrusted with dust. To avoid cracking the radiator, allow the radiator and cooler fins to cool before cleaning.

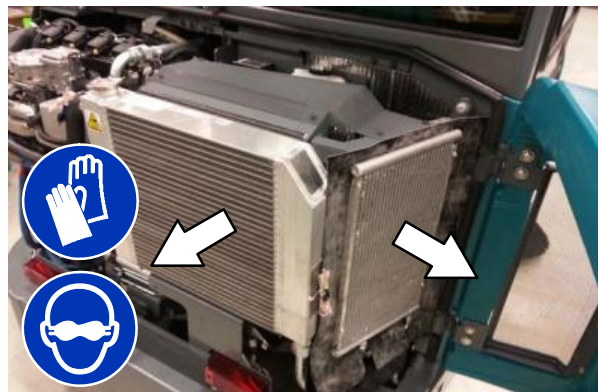

# MAINTENANCE

## AIR FILTER INDICATOR

Check the indicator daily. The indicator red line will move as the air filter element fills with dirt. Do not replace the air filter element until the red line reaches 5 kPa (20 in H<sub>2</sub>O) and the "SERVICE WHEN RED" window is filled with red. The engine must be running to get an accurate air indicator reading.

**FOR SAFETY:** When servicing machine, avoid moving parts. Do not wear loose clothing, jewelry and secure long hair.

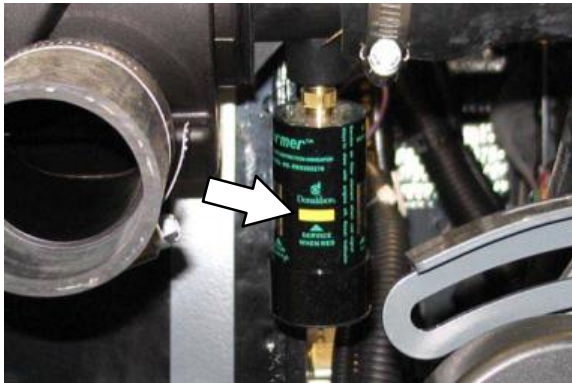

## AIR FILTER

**FOR SAFETY:** Before leaving or servicing machine, stop on level surface, set parking brake, turn off machine, and remove key.

The engine air filter housing is located in front of the engine compartment inside the left side shroud door.

Replace the air filter element when the air filter indicator shows restriction in the air intake system or the filter element is damaged. Refer to *AIR FILTER INDICATOR*.



Remove the filter element. Carefully clean the end cap and the interior of the housing with a damp cloth. Clean the housing sealing surfaces.

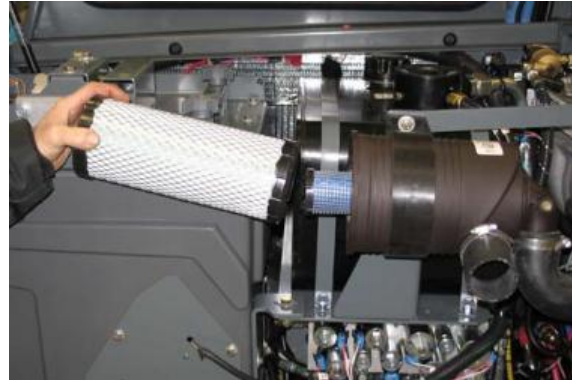

Replace the safety filter element after the primary has been changed three times. Do not remove the safety filter element from the housing unless it is restricting air flow.



Install the filter element into the air filter housing and reinstall the dust cap with the water drain pointing down.

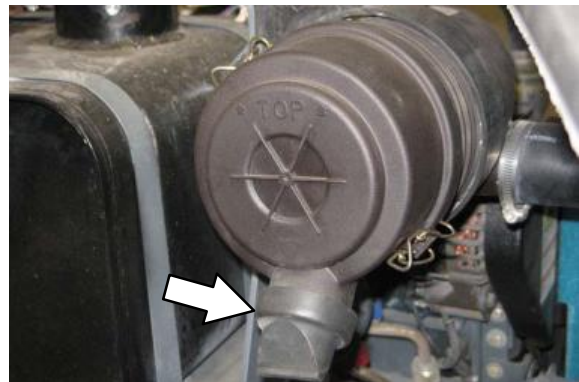



Push the reset button on the end of the indicator to reset the air filter indicator after replacing the air filter element.

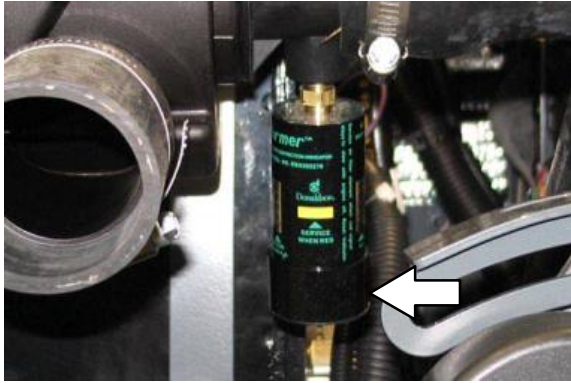

### FUEL FILTER

Replace the fuel filter after every 800 hours of operation.

**FOR SAFETY: When servicing machine, keep flames and sparks away from fuel system service area. Keep area well ventilated.**



### FUEL LINES

Check the fuel lines every 50 hours of operation. If the clamp band is loose, apply oil to the screw of the band and securely tighten the band.



The rubber fuel lines can become worn-out whether the engine has been used much or not. Replace the fuel lines and clamp bands every two years.

**FOR SAFETY: When servicing machine, keep flames and sparks away from fuel system service area. Keep area well ventilated.**

If the fuel lines and clamp bands are found worn or damaged before two years' time; replace or repair them at once. Bleed the fuel system after replacement of any fuel lines, see PRIMING THE FUEL SYSTEM. When the fuel lines are not installed, plug both ends with clean cloth or paper to prevent dirt from entering the lines. Dirt in the lines can cause fuel injection pump malfunction.

## MAINTENANCE

### PRIMING THE FUEL SYSTEM

Typical diesel fuel systems require priming to remove pockets of air from the fuel lines and fuel components. This is usually required after running out of fuel, changing fuel filter elements or repairing a fuel system component. Air in the fuel prevents smooth engine operation.

This fuel system however is self-priming. The return line comes from the top of the injector that allows the air to escape through the return line.

### ENGINE BELT

Check the belt tension after every 50 hours of operation. Adjust tension as necessary. Proper belt tension is 13 mm (0.50 in) from a force of 4 to 5 kg (8 to 10 lb) applied at the mid-point of the longest span.

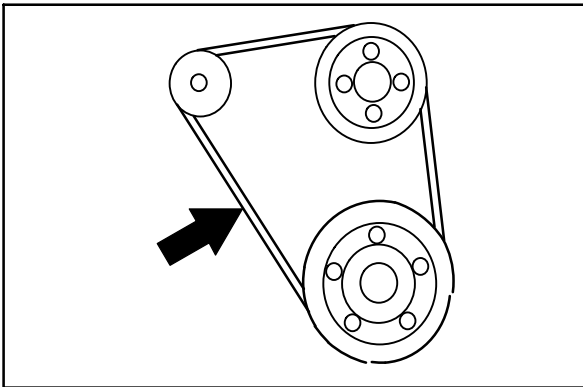

**WARNING:** Moving belt and fan. Keep away.

### BATTERY

Clean and tighten the battery connections after the first 50 hours of operation and after every 800 hours after that. Do not remove the vent plugs from the battery or add water to the battery.

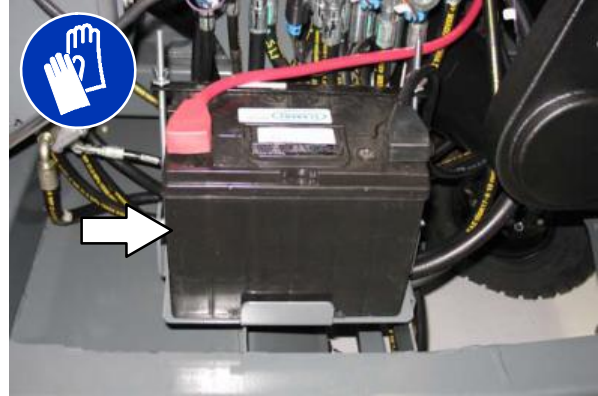

**FOR SAFETY:** When servicing machine, avoid contact with battery acid.

**FUSES AND RELAYS**

**RELAY PANEL FUSES AND RELAYS**

Remove the relay panel cover to access fuses and relays. Always replace a fuse with a fuse of the same amperage. Extra 15 Amp fuses are provided inside the relay panel drawer on the relay panel.



Refer to the diagram below for locations of the fuses and relays on the relay panel.

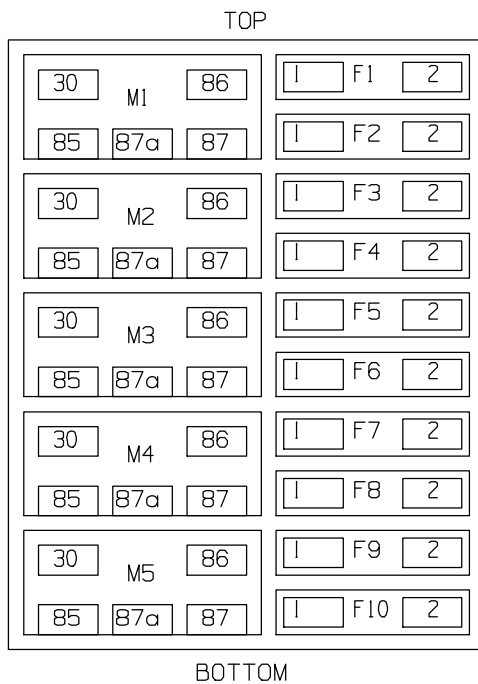

Refer to the tables below for the fuses and circuits protected.

S30		
Fuse	Rating	Circuit Protected
FU1	15 A	Horn
FU2	15 A	Key Switch, Engine, Instrumentation
FU3	15 A	Turn Signals, 4-Way Flashers
FU4	15 A	Extra Fused, Switched B+
FU5	15 A	Main Brush Valves, Side Brush Valves
FU6	15 A	Hopper Valves
FU7	15 A	Lights, Backup Alarm
FU8	15 A	Extra Fused B+
FU9	15 A	Shaker, Vacuum Fan Valve
FU10	25 A	Starter Solenoid
FU11	60 A	Main Power Fuse, In Line, In Main Harness
FU12	60 A	Cab Power (Optional)
FU13	40 A	Diesel Glow Plugs (In Engine Harness)
FU14	60 A	Cab Power (Optional)

S30 XP and X4		
Fuse	Rating	Circuit Protected
FU1	15 A	Horn
FU2	15 A	Key Switch, Engine, Instrumentation
FU3	15 A	Turn Signals, 4-Way Flashers, Shaker
FU4	15 A	Control Board
FU5	15 A	Main Brush Valves, Side Brush Valves
FU6	15 A	Hopper Valves, Vacuum Fan Valves
FU7	15 A	Lights, Backup Alarm
FU8	15 A	Extra Fused B+
FU9	15 A	Extra Switched, Fused B+
FU10	25 A	Starter Solenoid
FU11	60 A	Main Power Fuse, In Line, In Main Harness
FU12	60 A	Cab Power (Optional)
FU13	40 A	Diesel Glow Plugs (In Engine Harness)
FU14	60 A	Cab Power (Optional)

**NOTE:** Always replace a fuse with a fuse of the same amperage.

## MAINTENANCE

Refer to the tables below for the *relays* and circuits controlled.

S30		
Relay	Rating	Circuit Controlled
M1	12 VDC, 40 A	Horn
M2	12 VDC, 40 A	Auxiliary 1
M3	12 VDC, 40 A	Shaker
M4	12 VDC, 40 A	Main Brush Valves, Side Brush Valves
M5	12 VDC, 70 A	Auxiliary 2

S30 XP and X4		
Relay	Rating	Circuit Controlled
M1	12 VDC, 40 A	Horn
M2	12 VDC, 40 A	Auxiliary 1
M3	12 VDC, 40 A	Shaker
M4	12 VDC, 40 A	Not Used
M5	12 VDC, 40 A	Auxiliary 2

### ENGINE HARNESS RELAYS

The *engine harness relays* are located inside the engine compartment.

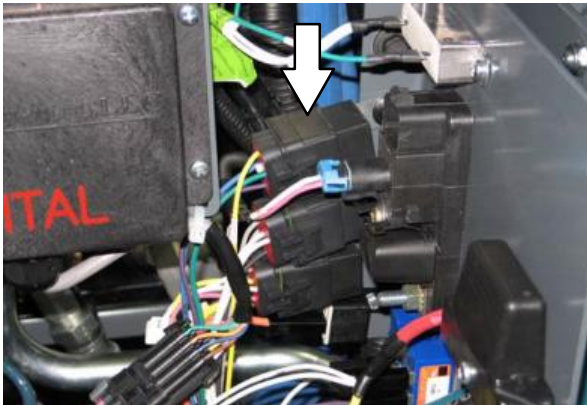

Relay	Rating	Circuit Controlled
M9	12 VDC, 40 A	Starter Solenoid
M10	12 VDC, 40 A	Anti-Restart
M11	12 VDC, 40 A	Fuel Pump
M12	12 VDC, 40 A	Glow Plug

**NOTE:** Always replace a fuse with a fuse of the same amperage.

### CAB FUSES (CAB OPTION)

The *cab fuses* are located in the fuse box inside the cab. Remove the fuse cover to access the fuses.



Refer to the table below for the *fuses* and circuits controlled.

Fuse	Rating	Circuit Protected
FU1	5 A	Lights
FU2	5 A	Wiper
FU3	20 A	Air Conditioner
FU4	2 A	Heat

**NOTE:** Always replace a fuse with a fuse of the same amperage.



### REMOVING AND INSPECTING THE DUST FILTER (SN 000000 – 006500)

Shake the dust filter at the end of every shift and before removing the filter from the machine. Inspect and clean the filter after every 100 hours of operation. Replace damaged dust filters.

*NOTE: Clean the filter more often if used in extremely dusty conditions.*

**FOR SAFETY: Before leaving or servicing machine, stop on level surface, set parking brake, turn off machine, and remove key.**

1. Open the top cover and side shroud.
2. Remove the filter shaker assembly from the filter housing.

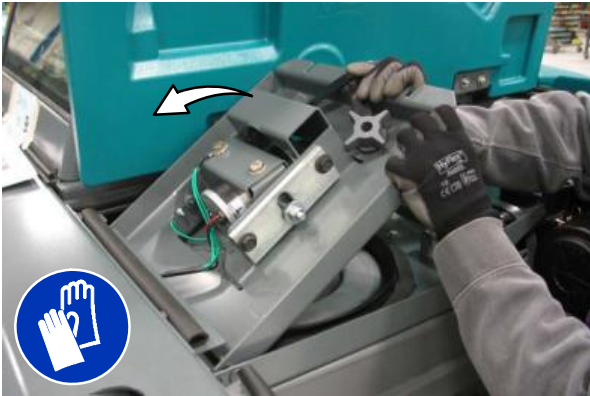

3. Remove the dust filter from the filter housing.



4. Clean or discard the dust filter element. Refer to *CLEANING THE DUST FILTER*.
5. Insert the dust filter into the filter housing and reinstall the removed parts. Be sure the seal is installed as shown below.



6. Close the side shroud and top cover.

## MAINTENANCE

### REMOVING AND INSPECTING THE DUST FILTER (SN 006501 - )

**FOR SAFETY:** Before leaving or servicing machine, stop on level surface, set parking brake, turn off machine, and remove key.

Shake the dust filter at the end of every shift and before removing the filter from the machine. Inspect and clean the filter after every 100 hours of operation. Replace damaged dust filters.

*NOTE: Clean the filter more often if used in extremely dusty conditions.*

1. Unlatch and open the hopper cover. Support the hopper cover open with the hopper cover prop rod.



2. Remove the dust filter cover.

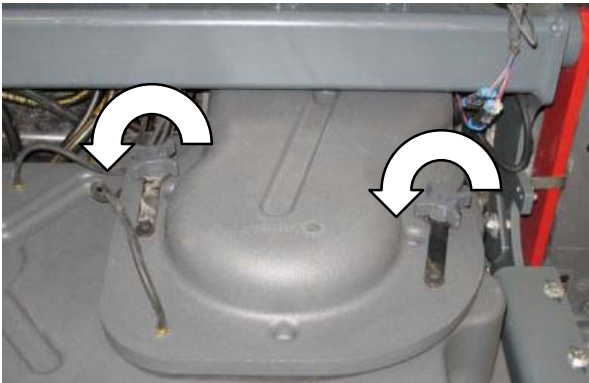

3. Remove the dust filter from the hopper.



4. Clean or discard the dust filter element. Refer to *CLEANING THE DUST FILTER*.

5. Clean dust and debris from the dust filter tray.



6. Reinstall the dust filter.

7. Reinstall the dust filter cover.

8. Close the hopper cover.

## CLEANING THE DUST FILTER

Use one of the following methods to clean the dust filter:

**SHAKING**—Press the *filter shaker switch*.

**TAPPING**—Tap the filter gently on a flat surface. **Do not damage the edges of the filter.** The filter will not seal properly if the edges of the filter are damaged.

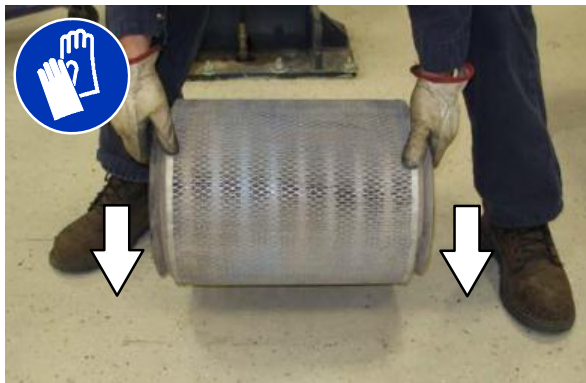

**AIR**—Always wear eye protection when using compressed air. Blow air through the center of the filter and out toward the exterior. Never use more than 550 kPa (80 psi) of air pressure with a nozzle no smaller than 3 mm (0.13 in) and never hold the nozzle closer than 50 mm (2 in) to the filter.



## CLEANING THE CYCLONE ASSEMBLY (SN 006501 - )

**FOR SAFETY:** Before leaving or servicing machine, stop on level surface, set parking brake, turn off machine, and remove key.

Clean the cyclones and filter housing after every 100 hours of operation.



Open the cyclone cover access port to empty dust and debris from the cyclone cover.

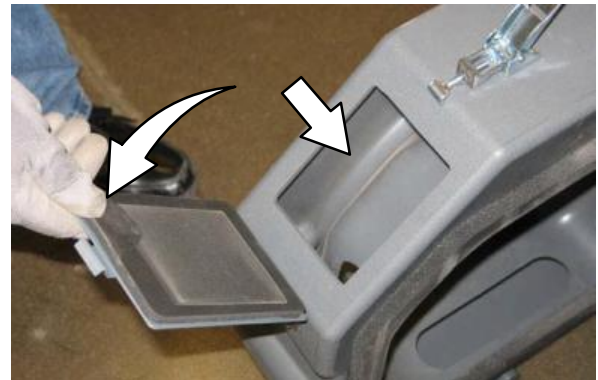



## MAIN BRUSH

**FOR SAFETY:** Before leaving or servicing machine, stop on level surface, set parking brake, turn off machine, and remove key.

Check the brush daily for wear or damage. Remove any string or wire tangled on the main brush, main brush drive hub, or main brush idler hub.



Rotate the brush end-for-end after every 50 hours of operation, for maximum brush life and best sweeping performance. Refer to *REPLACING OR ROTATING THE MAIN BRUSH*.

Replace the main brush when it no longer cleans effectively.

## REPLACING OR ROTATING THE MAIN BRUSH

1. Raise the brush head.

**FOR SAFETY:** Before leaving or servicing machine, stop on level surface, set parking brake, turn off machine, and remove key.

2. Open the right side main brush access door.



3. Unlatch and remove the brush idler plate.

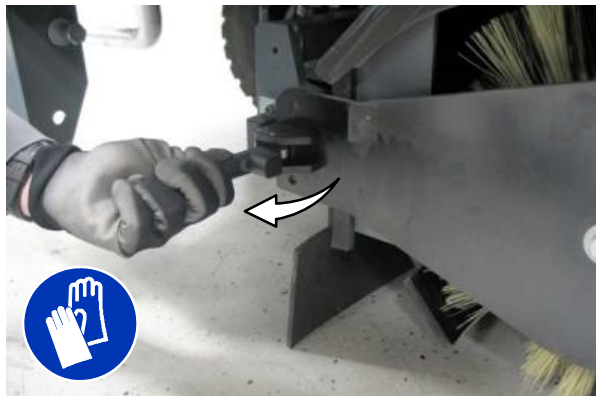

4. Pull the main brush from the main brush compartment.



5. Replace or rotate the main brush end-for-end.
6. Slide the brush into the brush compartment and all the way onto the drive plug.
7. Reinstall the brush idler plate.

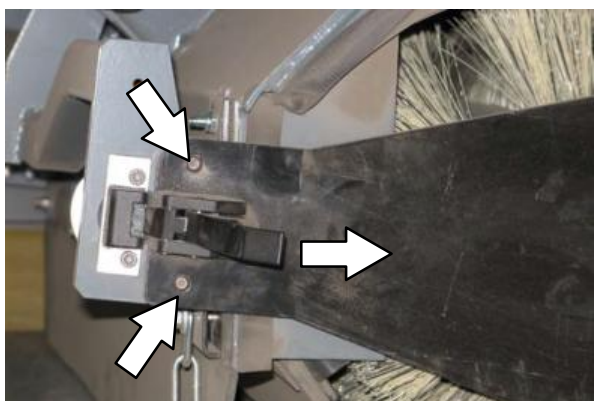

8. Close the right side main brush access door.
9. Check and adjust the brush pattern if needed after replacing or rotating it. Refer to *CHECKING THE MAIN BRUSH PATTERN*.

## MAINTENANCE

### CHECKING THE MAIN BRUSH PATTERN

1. Apply chalk, or a similar marking material, to a smooth and level section of the floor.

*NOTE: If chalk or other material is not available, allow the brush to spin on the floor for two minutes. A polish mark will remain on the floor.*

2. Lower the main brush onto the chalked area and hold it there for 15 to 20 seconds without moving the machine.
3. Raise the brush and drive the machine from the chalked area. The brush pattern should be 50 to 75 mm (2.0 to 3.0 in) across the entire length of the brush. Refer to **ADJUSTING THE MAIN BRUSH WIDTH**.

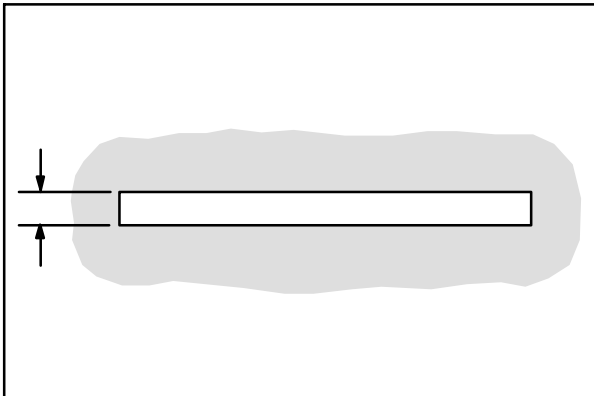

00582

4. If the brush pattern is tapered, see **ADJUSTING THE MAIN BRUSH TAPER** section of this manual.

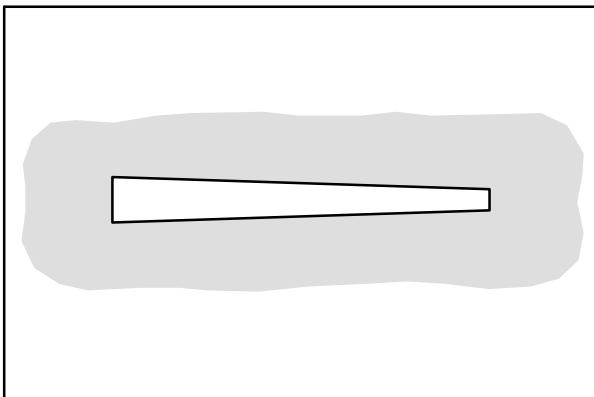

00601

### ADJUSTING THE MAIN BRUSH TAPER

**FOR SAFETY: Before leaving or servicing machine, stop on level surface, set parking brake, turn off machine, and remove key.**

1. Loosen the shaft bearing bracket mounting bolts.

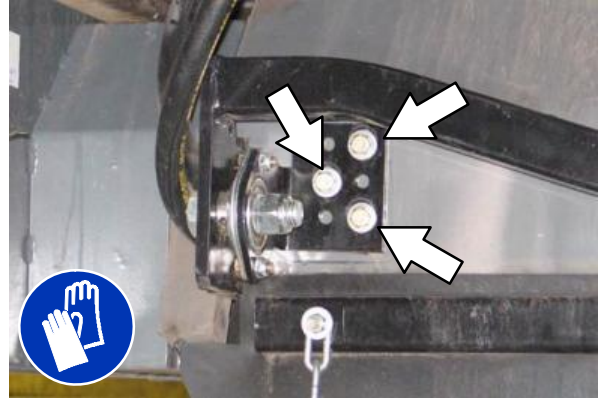

2. Move the bracket up or down in the slots and tighten the mounting bolts.
3. Check the main brush pattern and readjust as necessary. Set the main brush adjustment knob pointer to the same color band as the brush idler plate.



## ADJUSTING THE MAIN BRUSH WIDTH

**FOR SAFETY:** Before leaving or servicing machine, stop on level surface, set parking brake, turn off machine, and remove key.

1. Compare the length of the main brush bristles with the color band on the brush idler plate.

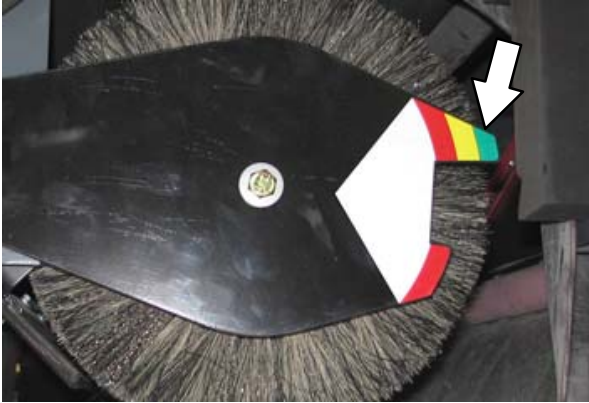

2. Loosen the main brush adjustment knob and slide the pointer so it matches the color band on the brush idler plate. Retighten the knob.

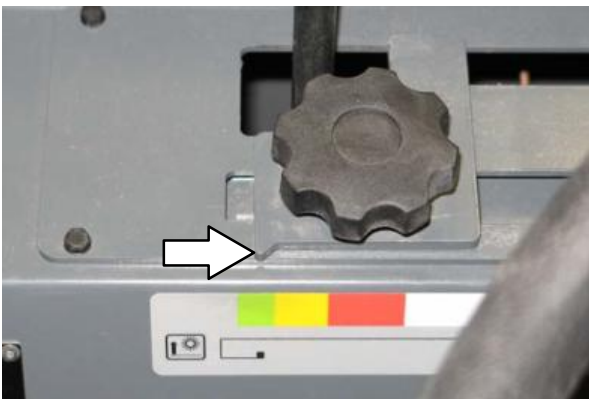

3. Recheck the pattern. Readjust if necessary.

## SIDE BRUSH

Check the side brush daily for wear or damage. Remove any tangled string or wire from the side brush or side brush drive hub.

### REPLACING THE SIDE BRUSH

Replace the side brush(es) when it no longer cleans effectively.

1. Raise the side brush.

**FOR SAFETY:** Before leaving or servicing machine, stop on level surface, set parking brake, turn off machine, and remove key.

2. Remove the side brush retaining pin and then remove the side brush.



**NOTE:** Remove the drive hub and put it on the new brush if one is not installed.

3. Slide the new side brush onto the side brush drive shaft and reinstall the retaining pin.
4. Adjust the side brush pattern. Refer to *ADJUSTING THE SIDE BRUSH PATTERN*.

## MAINTENANCE

### ADJUSTING THE SIDE BRUSH PATTERN

The side brush bristles should touch the floor between 10 o'clock and 4 o'clock when the brush is in motion.

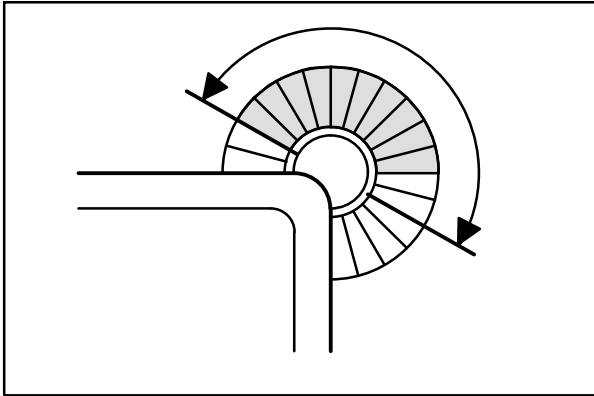

350327

**S30:** Turn the *side brush adjustment knob* counterclockwise to increase the brush pattern and clockwise to decrease the brush pattern.

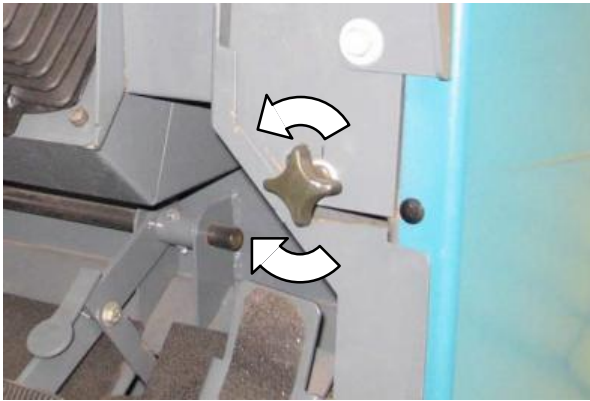

**S30 XP and X4:** Tighten the *side brush adjustment knob* into the side brush bracket to the decrease brush pattern and loosen the knob to increase the brush pattern.



### ROTATING AND REPLACING THE SIDE BRUSH GUARD

Rotate the side brush guard 90° every 200 hours of operation. Replace the brush guard after all four sides have been used.



**SKIRTS AND FLAPS**

**FOR SAFETY:** Before leaving or servicing machine, stop on level surface, set parking brake, turn off machine, and remove key.

**HOPPER SKIRTS**

Check the hopper skirts for wear or damage daily. Replace the hopper skirts when they no longer touch the floor.

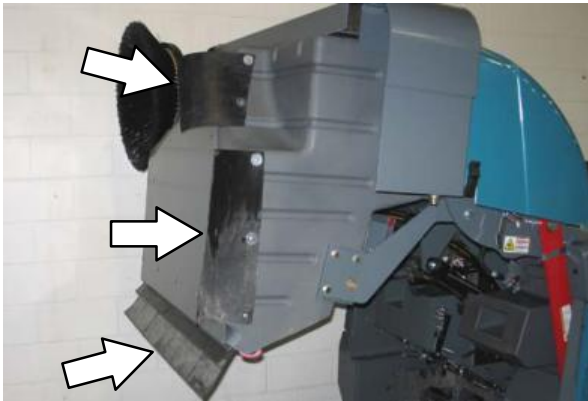
**BRUSH DOOR SKIRTS**

*NOTE:* Be sure the rear tire is properly inflated before checking skirt clearances.

The brush door skirts should clear the floor by 3 to 6 mm (0.12 to 0.25 in). Check the skirts for wear or damage and adjustment daily.



*NOTE:* The brush door skirts have slotted holes to allow for a ground clearance adjustment. The door must be closed for proper adjustment.

**REAR SKIRTS**

*NOTE:* Be sure the rear tire is properly inflated before checking skirt clearances.

The rear brush skirt should clear the floor by 3 to 6 mm (0.12 to 0.25 in). Check the skirt for wear or damage and adjustment daily.

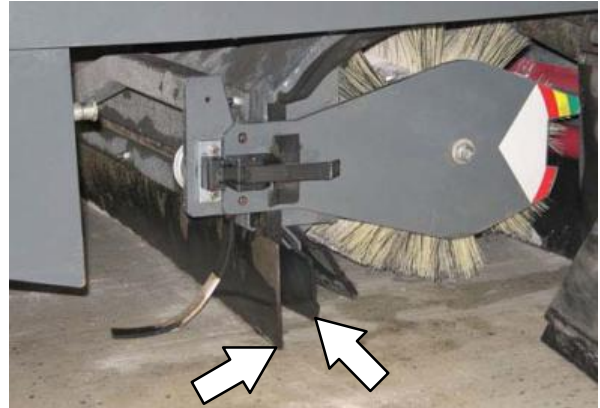
**RECIRCULATION FLAP**

The recirculation flap is self-adjusting. Check the flap for wear or damage daily.

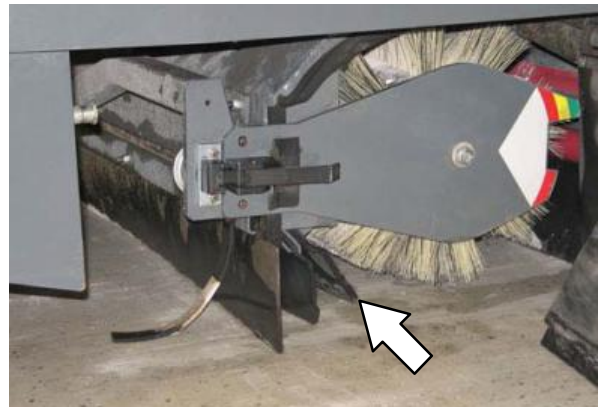



# MAINTENANCE

## SEALS

**FOR SAFETY:** Before leaving or servicing machine, stop on level surface, set parking brake, turn off machine, and remove key.

### BRUSH DOOR SEALS

Check the brush door seals for wear or damage every 100 hours of operation.

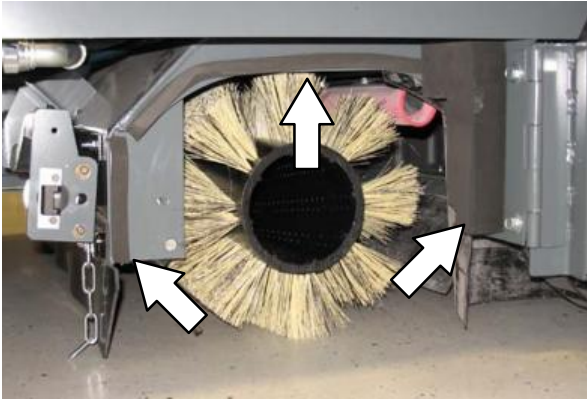

### HOPPER SEALS

Check the hopper door seals for wear or damage every 100 hours of operation.

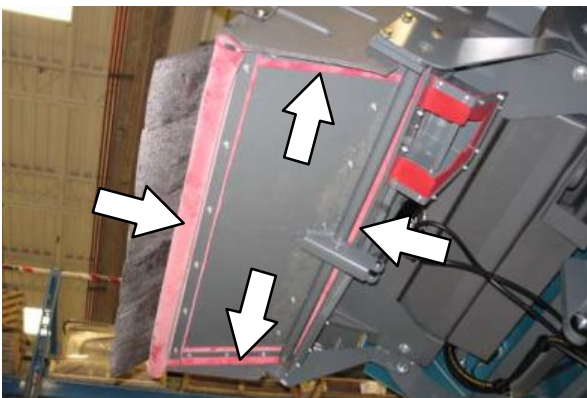
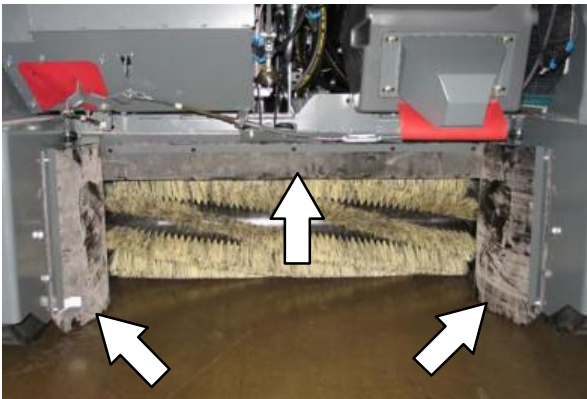

### HOPPER INSPECTION DOOR SEALS

Check the hopper inspection door seal for wear or damage every 100 hours of operation.



### FILTER CHAMBER INLET SEAL

Check the filter chamber inlet seal for wear or damage every 100 hours of operation.

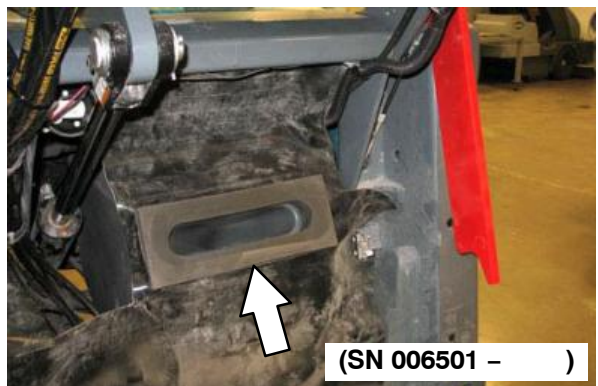
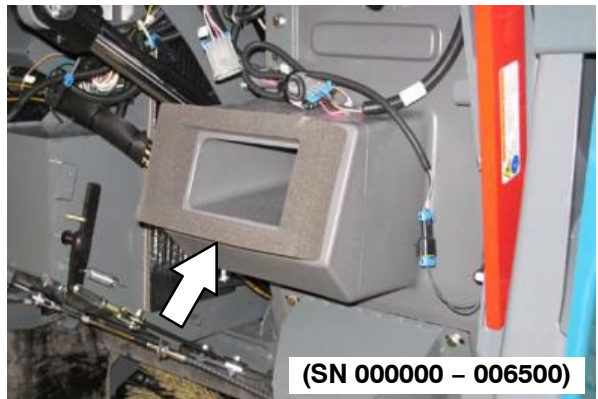

**CYCLONIC PRE-FILTER SEALS**

Check the cyclonic pre-filter seals for wear or damage every 100 hours of operation.

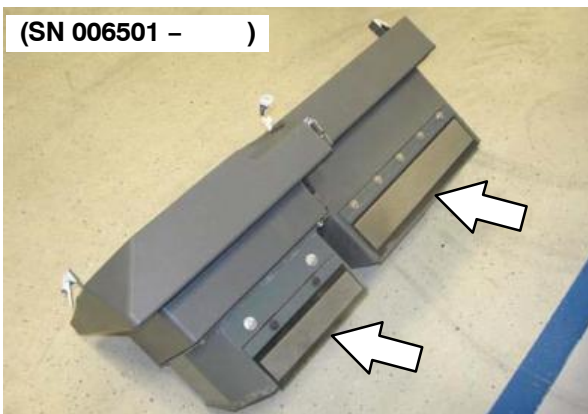
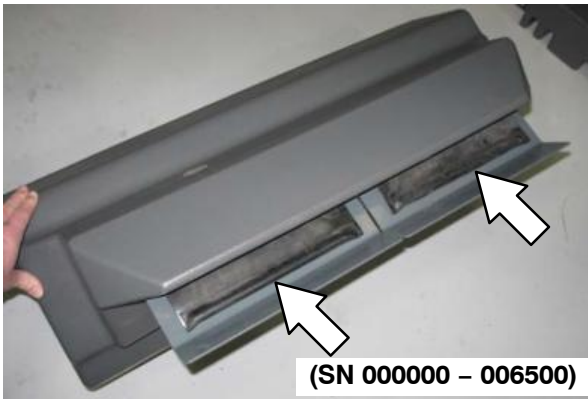

**DUST RETURN SEALS (SN 000000 - 006500)**

Check the dust return seals for wear or damage every 100 hours of operation.

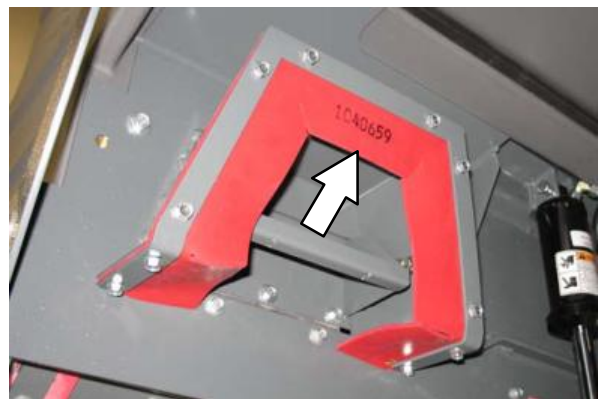
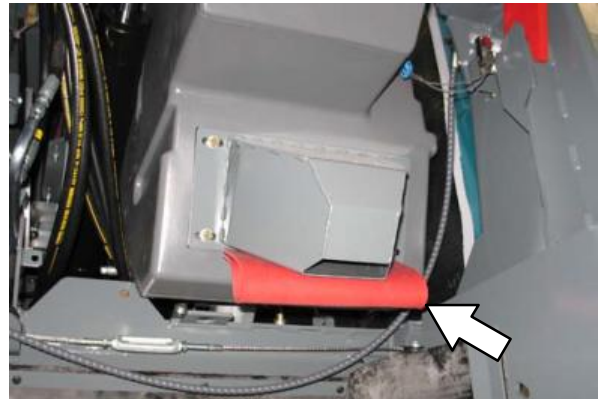

**DUST FILTER SEALS (SN 000000 - 006500)**

Check the dust filter seals for wear or damage every 100 hours of operation.

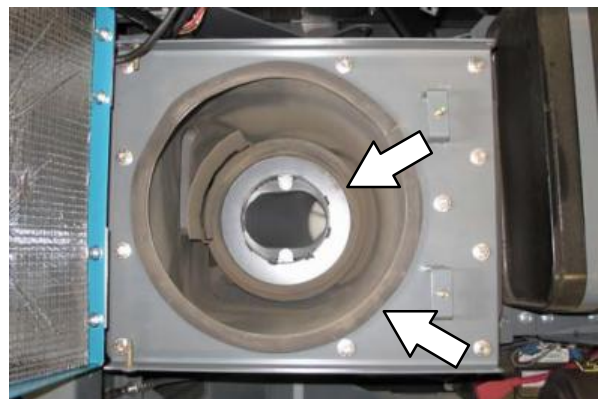

**VACUUM WAND DOOR SEALS (OPTION)**

Check the vacuum wand door seal for wear or damage every 100 hours of operation.



## MAINTENANCE

### CYCLONIC DUST TRAY SEALS (SN 006501 - )

Check the cyclone dust tray seals for wear, damage, and debris buildup every 100 hours of operation.

*NOTE: It is not necessary to remove the cyclone assembly from the machine to check / clean the seals.*

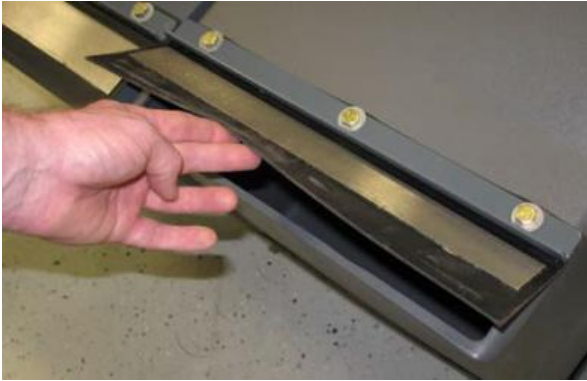

### CYCLONE PERMA-FILTER (SN 006501 - )

Clean heavy or wet dust and excess debris from the cyclone perma-filter as necessary. Check the cyclone perma-filter for damage every 100 hours of operation.

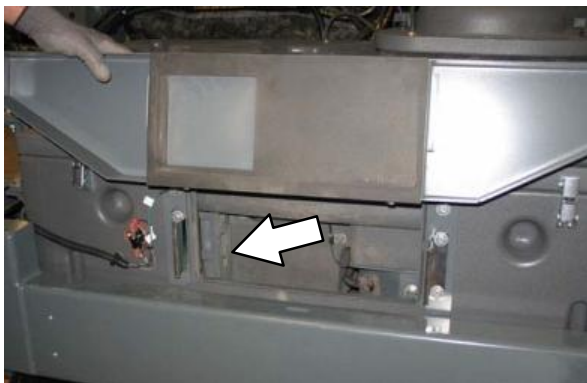

### CYCLONE COVER SEALS (SN 006501 - )

Check the cyclone cover seals for wear or damage every 100 hours of operation. Clean dust and debris from the cyclones as necessary.

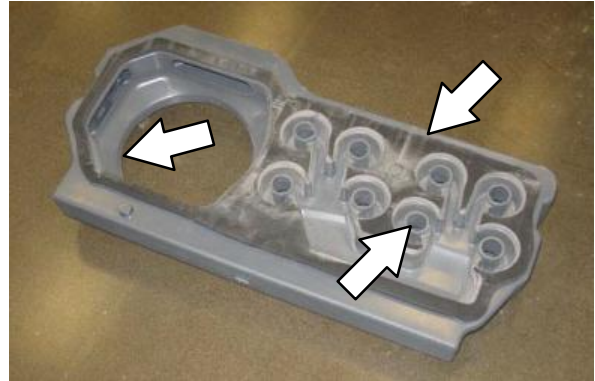

### CYCLONE COVER ACCESS PORT SEAL (SN 006501 - )

Check the cyclone cover access port seal for wear or damage every 100 hours of operation. Clean dust and debris from the seal as necessary.



### HOPPER DUST FILTER COVER SEAL (SN 006501 - )

Check the hopper dust filter cover seal for wear or damage every 100 hours of operation. Clean dust and debris from the seal as necessary.





**BRAKES AND TIRES**

**BRAKES**

Check the brake adjustment after every 200 hours of operation.

To check the brake adjustment, measure the distance from the stationary brake pedal to the point where there is resistance in the pedal movement. The distance must be 19 to 25 mm (0.75 to 1.0 in). Adjust the brakes if required.



**PROPELLING MOTOR**

Torque the shaft nut to 508 Nm (375 ft lb) lubricated, 644 Nm (475 ft lb) dry, after every 800 hours of operation.



**TIRES**

The standard front tires are solid. The standard rear tire is pneumatic.

Check the rear tire pressure every 100 hours of operation. The proper air pressure is  $790 \pm 35$  kPa ( $115 \pm 5$  psi).

**REAR WHEEL**

Torque the rear wheel nuts twice in the pattern shown to 122 to 149 Nm (90 to 110 ft lb) after the first 50 hours of operation, and then after every 800 hours.

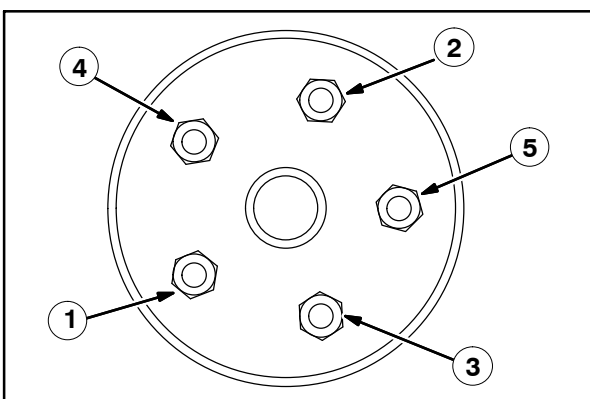

## PUSHING, TOWING, AND TRANSPORTING THE MACHINE

### PUSHING OR TOWING THE MACHINE

If the machine becomes disabled, it can be pushed from the front or rear, but only towed from the rear.

Use the *bypass valve* to prevent damaging the hydraulic system when pushing or towing the machine. This valve allows a disabled machine to be moved for a *very short distance* and at a speed to not exceed 1.6 kp/h (1 mph). The machine is NOT intended to be pushed or towed a long distance or at a high speed.

**ATTENTION! Do not push or tow machine for a long distance or damage may occur to the propelling system.**

Turn the *bypass valve* located on the bottom of the propelling pump 90° (either direction) from the normal position before pushing or towing the machine. Return the bypass valve to the normal position when finished pushing or towing the machine. **Do Not** use the bypass valve during normal machine operation.

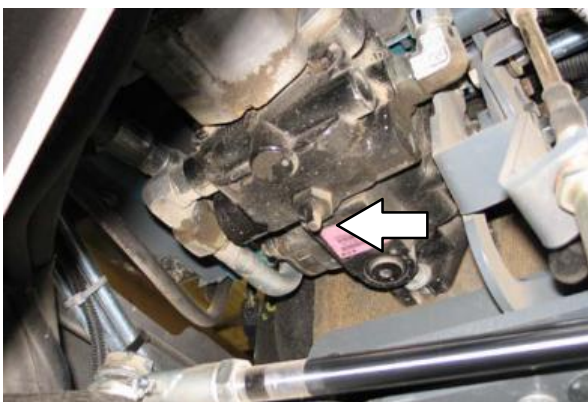
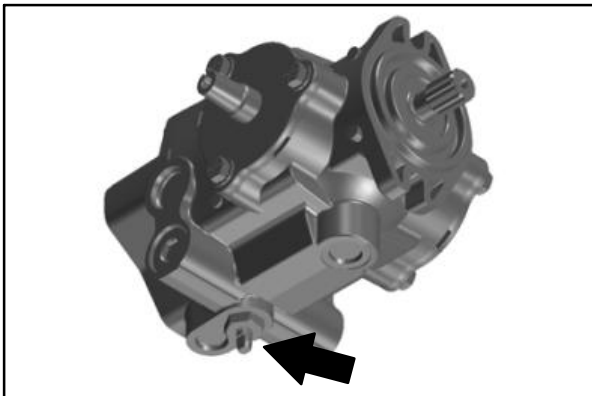

## TRANSPORTING THE MACHINE

1. Raise the brushes. If necessary, slightly raise the hopper for additional ramp clearance.

**FOR SAFETY: When loading machine onto truck or trailer, empty debris hopper before loading machine.**

2. Position the front of the machine at the loading edge of the truck or trailer.

**FOR SAFETY: When loading machine onto truck or trailer, use winch. Do not drive the machine onto the truck or trailer unless the loading surface is horizontal AND is 380 mm (15 in) or less from the ground.**

3. If the loading surface is horizontal and 380 mm (15 in) or less from the ground, drive the machine onto the truck or trailer.

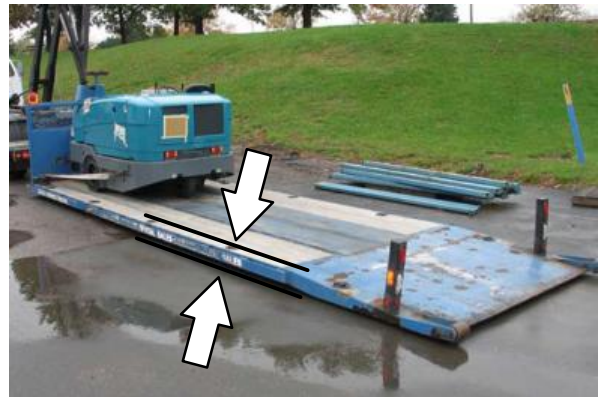

4. To winch the machine onto the truck or trailer, attach the winching chains to the holes in the right and left lower corners in front of the machine.



5. Position the machine as close to the front of the trailer or truck as possible.
6. Set the parking brake and place a block behind each wheel to prevent the machine from rolling.
7. Lower the brushes and hopper (if hopper was raised).
8. Connect the tie-down straps to the holes in the right and left lower corners in front of the machine and the holes in the rear jacking brackets behind the rear tires.

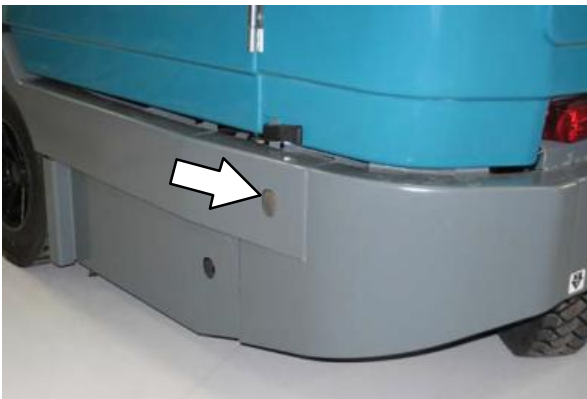

9. Route the tie-downs to the opposite ends of the machine and hook them to the brackets on the floor of the trailer or truck. Tighten the tie-down straps.

*NOTE: It may be necessary to install tie-down brackets to the floor of the trailer or truck.*



**FOR SAFETY: When unloading machine off truck or trailer, use winch. Do not drive the machine off the truck or trailer unless the loading surface is horizontal AND 380 mm (15 in) or less from the ground.**

10. If the loading surface is horizontal AND is 380 mm (15 in) or less from the ground, drive the machine off the truck or trailer.

# MAINTENANCE

## MACHINE JACKING

Empty the hopper before jacking up the machine. Jack up the machine at the designated locations. Use a hoist or jack capable of supporting the weight of the machine. Use jack stands to support the machine.

**FOR SAFETY: Before leaving or servicing machine, stop on level surface, set parking brake, turn off machine, and remove key.**

**FOR SAFETY: When servicing machine, block machine tires before jacking machine up. Use a hoist or jack that will support the weight of the machine. Jack machine up at designated locations only. Support machine with jack stands.**

Rear jacking locations are located directly behind the rear tire on each side of the machine.



Front jacking locations are located on the frame directly in front of the front tire.



## STORAGE INFORMATION

The following steps should be taken prior to storing the machine for extended periods.

1. Park the machine in a cool, dry area. Do not expose the machine to rain or snow. Store indoors.
2. Remove the battery, or charge battery every three months.

**SPECIFICATIONS**

**GENERAL MACHINE DIMENSIONS/CAPACITIES**

Item	Dimension/capacity
Length	2360 mm (93 in)
Height	1475 mm (58 in)
Height (with overhead guard or cab machine with AC)	2095 mm (82.5 in)
Width/frame	1590 mm (62.5 in)
Wheel base	1226 mm (48.25 in)
Track	1426 mm (56.125 in)
Cleaning path width (Single side brush)	1590 mm (62.5 in)
Cleaning path width (Dual side brushes)	2030 mm (80 in)
Main brush diameter	356 mm (14 in)
Side brush diameter	660 mm (26 in)
Debris hopper volume capacity (Plastic and Steel)	395 L (14 ft <sup>3</sup> )
Debris hopper weight capacity (Plastic)	490 kg (1080 lbs)
Debris hopper weight capacity (Steel)	545 kg (1200 lbs)
Dump height (variable to)	1525 mm (60 in)
Minimum ceiling dump height	2500 mm (98 in)
Weight – empty	1595 Kg (3520 lbs)
GVWR	2585 Kg (5700 lbs)
Transport ground clearance	100 mm (4 in)
Protection Grade	IPX3

Values determined as per IEC 60335-2-72	Measure
Sound pressure level $L_{pA}$	80 dB(A)
Sound pressure uncertainty $K_{pA}$	3 dB(A)
Sound power level $L_{WA}$ + Uncertainty $K_{WA}$	102 dB(A)
Vibration – Hand–arm	<2.5 m/s <sup>2</sup>
Vibration – Whole body	<0.5 m/s <sup>2</sup>

**GENERAL MACHINE PERFORMANCE**

Item	Measure
Minimum aisle turn (S30 and S30 XP)	2870 mm (113 in)
Minimum aisle turn (S30 X4)	5000 mm (196.75 in)
Travel speed forward (maximum) (S30 and S30 XP)	13.0 Km/h (8 mph)
Travel speed forward (maximum) (S30 X4)	24.0 Km/h (15 mph)
Travel speed reverse (maximum) (All Models)	5.0 Km/h (3 mph)
Maximum ramp incline for loading – Empty (S30 and S30 XP)	25%
Maximum ramp incline for loading – Empty (S30 X4)	16%
Maximum ramp incline for sweeping (All Models)	14%
Maximum ramp incline for transporting (GVWR) (S30 and S30 XP)	17%
Maximum ramp incline for transporting (GVWR) (S30 X4)	10.5%

# SPECIFICATIONS

## HYDRAULIC SYSTEM

System	Capacity	ISO Grade Viscosity Index	Ambient Air Temperature Ranges
Hydraulic reservoir	38 L (10 gal)	ISO 100 VI 126 or higher	19° C (65° F) or higher
Hydraulic total	45 L (12 gal)	ISO 68 VI 155 or higher	7 to 43° C (45 to 110° F)
		ISO 32 VI 163 or higher	16° C (60° F) or lower

## STEERING

Type	Power source
Rear wheel, hydraulic cylinder	Hydraulic accessory pump

## POWER TYPE

Engine	Type	Ignition	Cycle	Aspiration	Cylinders	Bore	Stroke
Kubota V1505-B	Piston	Diesel	4	Natural	4	78 mm (3.07 in)	78.4 mm (3.09 in)
	Displacement		Tennant governed power			Gross intermittent power per SAE J1995	
	1500 cc (91.4 cu in)		18.5 kw (24.8 hp) @ 2300 rpm			18.5 kw (24.8 hp) @ 2300 rpm	
	Fuel		Cooling system			Electrical system	
	Diesel Fuel tank: 42 L (11.2 gal) low sulfur fuel content less than 500ppm only *5% maximum biodiesel		Water/ethylene glycol antifreeze			12 V nominal	
			Total: 7.5 L (2 gal)			75 A alternator	
			Radiator: 3.8 L (1 gal)				
	Idle speed, no load		(Fast) governed speed, under load			Engine lubricating oil without filter	
1350 ± 50 rpm		2000 ± 50 rpm 2400 ± 50 rpm			6 L (6.35 qt) API diesel classification CF or better		

## BRAKING SYSTEM

Type	Operation
Service brakes	Mechanical drum brakes (2), one per front wheel, cable actuated
Parking brake	Utilize service brakes, cable actuated

## TIRES

Location	Type	Size
Front (2)	Solid	127 mm x 535 mm (5 in x 21 in)
Rear (1) (S30 and S30 XP)	Pneumatic	115 mm x 470 mm (4.5 in x 18.5 in)
Rear (2) (S30 X4)	Foam Fill	115 mm x 410 mm (4.5 in x 16 in)



**MACHINE DIMENSIONS**

