

RX 10/09 EVO GEL

FULLY FEATURED COMPACT STACKER



MONO MAST STACKER

RX is the most compact in the stackers' range, single mast, completely electric, suitable for loads up to 1.000 kg, allowing a comfortable, safe use, with low maintenance costs, thanks to robust design with easy access for maintenance. RX combines compactness and ergonomics, covering a wide range of daily applications in the "light duty" area (not for continuous use).



RX EVO GEL

The EVO version is equipped with powerful GEL batteries that allow long endurance and large number of charging cycles. The ergonomic technopolymer tiller offers a comfortable grip. A specific electronic control enables lifting the forks with a proportional usage.



TILLER EVOLUTION

Fully integrated ergonomic technopolymer tiller system including finger tip throttle and proportional fork controls, safety pushbutton, horn, turtle button, hourmeter, battery status indicator as standard equipment.



TURTLE MODE SWITCH

Offered as standard, this function enables operating the truck in confined spaces: it allows the unit to travel with the tiller in upright position.

This function is activated by pressing the turtle button on the tiller and rotating the drive control throttle. The truck travels at limited speed.

Release the button to disable this function.



VERSATILITY

It's ideal to move, even horizontally, palletized goods and at the same time it can be used as an adjustable workable, reducing stress for the operator who must place goods on a shelf. Forks thickness 60 mm for an easier entrance inside pallet, while working in elevation.



EASY MAINTENANCE

Strong ABS carter/cover with storage compartments on top. Easily removable to speed up maintenance operations. The bottom access opening allows an immediate disassembly of motor wheel, portal and tiller without lifting the machine.



ERGONOMICS

Ergonomic tiller placed laterally to increase visibility, ensuring an optimal arrangement of components inside the motor compartment. RX 10 solves perfectly the problem of handling goods in narrow spaces and corridors.



BATTERY PACK GEL

The use of powerful high energy throughput GEL batteries makes the machine extremely flexible in every application, thanks to the multiples benefits of GEL technology, such as:

- Maintenance-free (no topping up)
- Long service life
- High number of cycles (IEC 60254-1)
- Extraordinary deep discharge protection
- Low self discharge rate
- Superior shelf life
- No acid stratification



AUTOLEVELLING SYSTEM (OPTIONAL)

This device allows an automatic forks lifting and lowering control depending on the load height. The positioning of the sensor is easy adjustable through the magnets and can be done on both side of the mast for maximum ergonomic. The operator safety is granted by limit switches and a beeper that advice the beginning of the action. Autolevelling can be offered also as a retrofit available for all the RX10 EVO range.



Description

1.1 Manufacturer			PR INDUSTRIAL
1.3 Drive			ELECTRIC
1.4 Operator type			Pedestrian
1.5 Load capacity	Q	kg	1000
1.6 Load centre distance	c	mm	600
1.8 Load axle to end forks	x	mm	786
1.9 Wheel base	y	mm	1165

Weights

2.1 Service weight (battery included)		kg	345
2.2 Axle load, laden rear		kg	934
2.2 Axle load, laden front		kg	411
2.3 Axle load, unladen front		kg	246
2.3 Axle load, unladen rear		kg	99

Tyres/Chassis

3.1 Tyres: front wheels			RUBBER
3.1 Tyres: stabilizers wheels - front			POLY C.
3.1 Tyres: rear wheels			POLY C.
3.2 Tyre size: Steering wheels - Width		mm	50
3.2 Tyre size: Steering wheels - Diameter		mm	186
3.3 Tyre size: Load rollers - Diameter		mm	82
3.3 Tyre size: Load rollers - Width		mm	70
3.4 Tyre size: stabilizers wheels front - Diameter		mm	125
3.4 Tyre size: stabilizers wheels front - Width		mm	45
3.5 Tyre size: rear wheels - Q.ty (X=driven)		nr	2
3.5 Tyre size: front wheels - Q.ty (X=driven)		nr	1x
3.6 Tread, front	b10	mm	505
3.7 Tread, rear	b11	mm	410

Dimensions

4.2 Height, mast lowered	h1	mm	1270
4.3 Normal free lifting	h2	mm	810
4.4 Lift height	h3	mm	810
4.5 Height, mast extended	h4	mm	1270
4.9 Height of tiller in drive position min	h14	mm	968
4.9 Height of tiller in drive position max	h14	mm	1338
4.15 Height, lowered	h13	mm	90
4.19 Overall length	l1	mm	1675
4.20 Length to face of forks	l2	mm	522
4.21 Overall width	b1/ b2	mm	794
4.22 Fork dimensions - Thickness	s	mm	60
4.22 Fork dimensions - Width	e	mm	150
4.22 Fork dimensions - Length	l	mm	1153
4.24 Fork carriage width	b3	mm	650
4.25 Distance between fork arms	b5	mm	560
4.32 Ground clearance, centre of wheelbase	m2	mm	20
4.34 Aisle width	Ast	mm	2120
4.35 Turning radius	Wa	mm	1344

Performance data

5.1 Travel speed laden	km/h	3.7
5.1 Travel speed unladen	km/h	4.3
5.2 Lifting speed laden	m/s	0.12
5.2 Lifting speed unladen	m/s	0.21
5.3 Lowering speed laden	m/s	0.25
5.3 Lowering speed unladen	m/s	0.21
5.8 Max gradeability laden	%	10
5.8 Max gradeability unladen	%	15
5.10 Service brake		REVERSE CURRENT

Electric motors

6.1 Drive motor power	kW	0.35
6.2 Lift motor power	kW	2.2
Battery Type	Type	GEL
6.4 Battery voltage	V	24
6.4 Battery capacity, Min	Ah	50
6.4 Battery capacity, Max	Ah	50
6.5 Battery weight, Min	kg	38
6.5 Battery weight, Max	kg	38
6.6 Energy consumption according to VDI cycle	kWh/h	0.45
8.4 Sound level at driver's ear	dB(A)	63

Battery and battery charger integrated

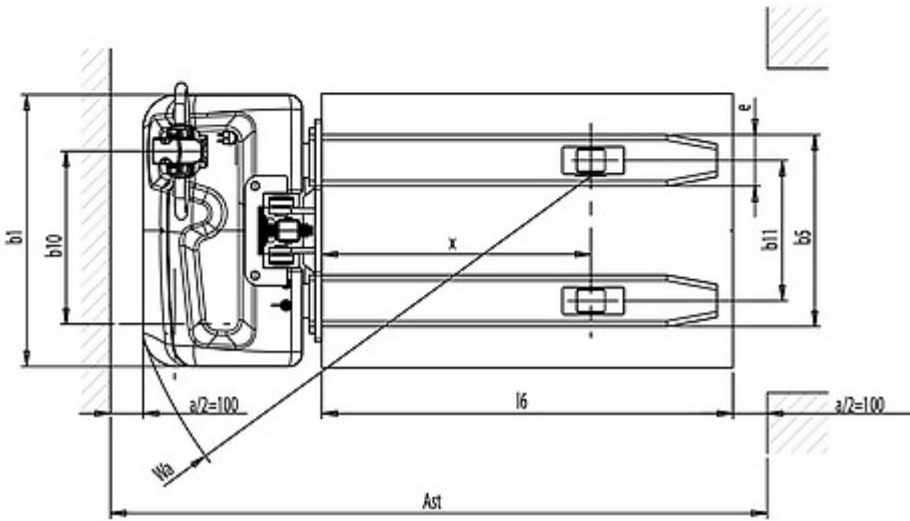
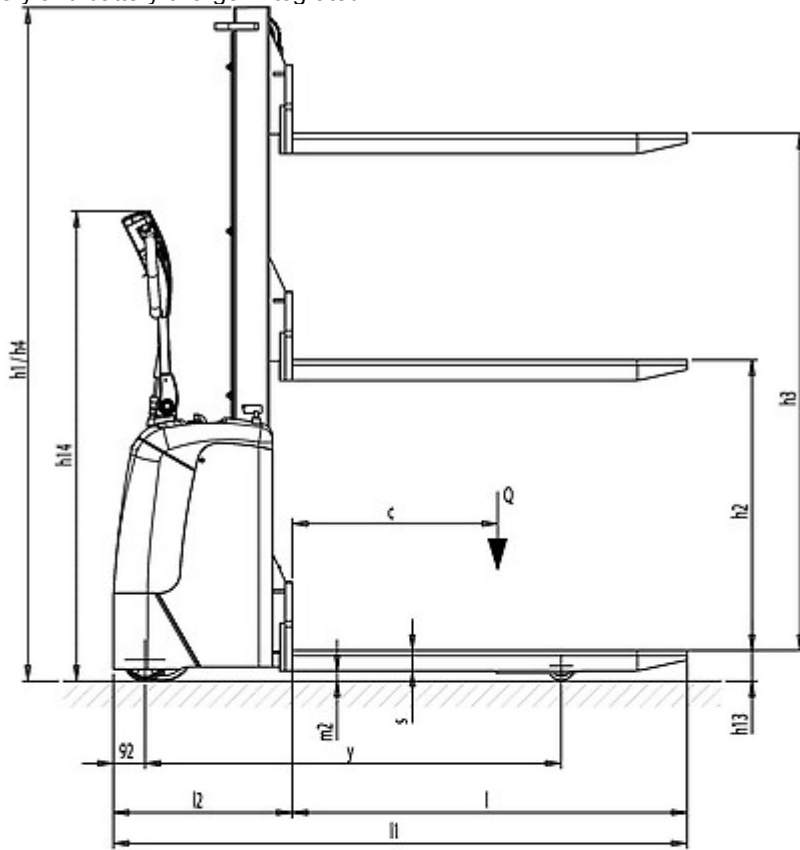

The information is aligned with the Data file at the time of download. Printed on 25/08/2022 (ID 6375)

©2022 | PR INDUSTRIAL s.r.l. | All rights reserved | Image shown may not reflect actual package. Specifications subject to change without notice

